



 **İŞLER KAUÇUK**
Sızdırmazlık Teknolojileri

İŞLER KAUÇUK HAKKINDA

Teknolojik yeniliklerin hızla geliştiği ve dünya çapında rekabetin hız kazandığı bir çağda yaşıyoruz. Üretim ve yönetimin her alanını, çalışanların tümünün aktif katılımlarını ve yapılan işlerin tüm yönlerini kapsayan toplam kalite yönetiminin hedefi müşteri beklentilerinin tam olarak anlaşılması ve karşılanmasıdır. Firmaların üretim ve hizmet anlayışlarını, ürettikleri ürün ve hizmetlerle birlikte müşteriye ulaşıncaya kadar her aşamada korumak ve geliştirmek, başarı ivmesi kazanmak için temel anlayış olmalıdır.

İŞLER KAUÇUK bu temel anlayışı benimseyerek 1995 yılında daha önceki tecrübe ve bilgisi ışığında ilk üretimine başladı. Her geçen gün geliştirdiği bilgi, tecrübe, teknoloji ve başarı niteliklerini birleştirerek imalat, özel tasarım, satış ve danışmanlık hizmetleri ile sürekli gelişim ivmesi kazanarak sektörün lider kuruluşları arasında yerini aldı. Hidrolik, pnömatik sistemler ile çalışan her makinenin ihtiyacına cevap verebilecek sızdırmazlık elemanları ve teknik kauçuk parça imalatını kapsayan geniş ürün yelpazesi ve kaliteden ödün vermeyen anlayışıyla İŞLER KAUÇUK sektördeki payını artırmaya devam etmektedir.

About İŞLER KAUÇUK

We live in an age where technological innovations are developed fast and competition is spread worldwide. The target of the total quality management that contains the participation of all staff and all aspects of tasks performed is to comprehend and satisfy customer's expectations. To be success in an accelerating rate, a company should protect and improve the production service policies that it adopted in all stages from the beginning to delivery of products an/or service to customers. İŞLER KAUÇUK, adopting this basic approach started its productions in 1995 in the light of the experience and knowledge that it accumulated from its past. Combining knowledge, experience technology and success which all have been improving day by day, it has been increasingly developing and has become one of the leading companies of the market.

İŞLER KAUÇUK, is continuing to increase its share in the market, without compromising quality and its wide product range containing sealing components and technical rubber parts that can meet the requirements of every machine operated by hydraulic and pneumatic systems.

HİDROLİK PNÖMATİK SIZDIRMAZLIK ELEMANLARI HAKKINDA GENEL BİLGİLER

Akışkan teknolojisinde kullanılan sızdırmazlık elemanları sistemin emniyet riskini taşıyan önemli unsurlardır. Sızdırmazlık elemanlarında oluşabilecek arıza ve hatalar sistemin verimliliğini ve güvenilirliğini kaybetmesine sebep olur.

Sızdırmazlık elemanları uygulama yerine göre statik ya da dinamik olmak üzere iki grupta toplanırlar. Statik kullanılan elemanlar iki sabit parça arasındaki sızdırmazlığı sağlar. Statik sızdırmazlık elemanları yapısal, fiziksel, ortam sıcaklığı vs. gibi etkenlerden dolayı kendi aralarında sınıflanırlar. Dinamik elemanlar ise hareket eden parçalar arasındaki akışkanın sızdırmazlığını sağlar. Dinamik sızdırmazlık elemanlarında yine, yapısal, fiziksel, ortam sıcaklığı, akışkan türü vs. gibi etkenlerden dolayı kendi aralarında sınıflanırlar. Dinamik elemanlar radyal ve eksenel sızdırmazlık amacıyla iki grupta imal edilirler.

İŞLER KAUÇUK olarak temel imalat programımız elastomer ürünler üzerine yoğunlaşmıştır. Elastomer malzemeler kısa süreli yük ve baskılarda fiziksel yapısını koruma ve hafıza alabilme özelliğine sahiptir. Bu ürünlerin imalat süreçleri ve malzeme imalatı oldukça zahmetli ve bir o kadar teknik bilgi gerektirmektedir.

Doğru malzeme seçimi ürünün kullanıldığı yer ve toleransları için çok büyük önem taşımaktadır. Aksi halde sistemde ciddi arızalara ve beklenmeyen sonuçlara neden olur.

Sızdırmazlık elemanının doğru seçimi için önce imalatçı firma ile görüşülmelidir. Ancak imalatçı firmanın bilgi ve tecrübelerinin yardımıyla doğru eleman seçimi, tasarım, toleranslar ve uygulama teknikleri hakkında daha net bilgiler edinilebilir.

Hydrolic Pnuematic Sealing Compo nents

Sealing components used in fluidity technology prove to be very important in terms of system safety risk. Any breakdown or errors which could occur in sealing components may result in loss of system efficiency and safety.

Sealing components could be grouped into two as static and dynamic depending on application area. Components used as static ensure sealing between two static parts. Static sealing components can be subgrouped in accordance with structural, physical factors and ambient temperature. Dynamic components ensure the sealing of fluid between moving parts. Dynamic sealing components can be subgrouped likewise depending on structural, physical factors, ambient temperature and type of the fluid. Dynamic components are produced for two aims which are radial and axial sealing.

As İŞLER KAUÇUK/RUBBER, our main production schedule is concentrated on elastomer products. Elastomer materials are capable of maintaining their physical structure and recording things in memory in case of short-term load and pressure. The manufacturing of these products and materials is quite burdensome and requires technical knowledge. Correct choise of materials is crucial in terms of area of use and tolerance. Otherwise, it may culminate in major breakdown or unexpected outcomes.

Contact should be established with the manufacturing company in order to choose the right sealing materials. Correct choise of materials, good design, right tolerances and application techniques can only be achieved through the expertise and help of the manufacturing company.

S E R T İ F İ K A

C E R T İ F I C A T E

KALİTE YÖNETİMİ / QUALITY MANAGEMENT
İŞLER KAUÇUK SANAYİ VE TİCARET LTD. ŞTİ.

kuruluşunun,
company,

Abdi İpekçi Cad. 1. Emintaş Sanayi Sitesi No:158/53 Bayrampaşa /TÜRKİYE
adresinde,
at adress

HİDROLİK – PNÖMATİK SIZDIRMAZLIK ELEMANLARI
ÜRETİMİ VE SATIŞI

HYDRAULIC - PNEUMATIC SEALS PRODUCTION AND SALES

EA 14 kapsamında
At scope EA 14

kalite yönetim sistemi yürürlüğe koyduđu;
perform the quality management system;

ISO 9001:2008

standart taleplerinin yerine getirildiđi belirlenmiştir.
the complete of the standard was determined.

İlk Yayın Tarihi / Date First Registered :10.07.2014
Yayın Tarihi / Date Certificate Issued :10.07.2014
Geçerlilik Periyodu / Period of Registration :3 YIL
Geçerlilik Tarihi / Date Certificate Expires:09.07.2015
Sertifika Numarası / Certificate No :01/10820/01-TR

Onay :
Approver:













Kalite Yönetim Sistemi
TS EN ISO / IEC 17021
AB - 0060 - YS

Bu sertifikanın geçerliliđi, yılda en az bir kez yapılacak gözetim denetiminin başarılı geçmesine bađıdır. Bu durumda belge yeniden düzenlenecektir.
The Validity of this certificate, subject to successful completion of surveillance audit which will take place at least once a year. In this case, the document will be revised.















ASB Uluslararası Belgelendirme Gözetim Denetim ve Eğitim Hiz. Ltd. Şti. / ASB International Certification Surveillance, Auditing and Training Services Ltd. Company
Tatlısu Mh. Tezcan Cd. No:50/2 34775 Ümraniye - İstanbul / TÜRKİYE Tel: +90 216 526 10 04 Fax: +90 216 526 30 91 e-mail: bilgi@asbcert.com - info@asbcert.com
Bu sertifika, kuruluşun ASB'nin şartlarına uyduđu sürece geçerlidir. Sertifikanın durumu www.asbcert.com adresinden kontrol edilebilir.
The Validity shall remain in force as long as the corporation follows instructions of ASB. Certificates status can be checked at www.asbcert.com

Profil	Kod	Açıklama	Malzeme	Basınç max (bar)	Isı max (°C)	Kayma Hızı	Sayfa No
	İS1 İS2 İS4	Takım Keçeler	NBR-Bez NBR FKM-Bez FKM	NB 0175 N 0185 Fb 0375 F 0385	400	-30 → +110 -30 → +225	≤ 0,5 11
	İS3	Piston Takım Keçe	NBR-Bez NBR FKM-Bez FKM	Nb 0175 N0185 Fb 0375 F0380	400	-30 → +110 -30 → +225	≤ 0,5 15
	İS10	Nutring Keçe	NBR FKM PU	N0190 F0382 P 0292	150 150 400	-30 → +110 -30 → +225 -30 → +100	≤ 0,5 16
	İS12	Rod Nutring	NBR FKM PU	NB 0190 F 0384 P 0292	150 150 400	-30 → +110 -30 → +225 -30 → +100	≤ 0,5 32
	İS13	Piston Nutring	NBR FKM PU	N 0185 F 0382 P 0292	150 150 400	-30 → +110 -30 → +225 -30 → +100	≤ 0,5 35
	İS30	Kompakt Keçe	NBR-Bez NBR FKM-Bez FKM	Nb 0170 N 0180 Fb 0370 F 0380	350	-30 → +110 -30 → +225	≤ 0,5 39
	İS93	Toz Keçesi	NBR FKM PU	N 0190 F 0385 P 0292		-30 → +110 -30 → +225 -30 → +100	≤ 1 41
	İS32	Yastıklama Keçeleri	NBR FKM	N 0190 F 0392	12	-30 → +110 -30 → +225	≤ 1 44
	İS36	Kademeli Toz Keçesi	NBR FKM PU	N0190 F 0385 P 0292		-30 → +110 -30 → +225 -30 → +100	≤ 1 45
	İS18	Nutring Dudaklı Toz Keçesi	NBR FKM	N0190 F 0382	12 12	-30 → +110 -30 → +225	≤ 1 46
	İS21	Nutring Dudaklı Toz Keçesi	NBR FKM	N0190 F 0382	12 12	-30 → +110 -30 → +225	≤ 1 48

Profil	Kod	Açıklama	Malzeme	Basınç max (bar)	Isı max (°C)	Kayma Hızı	Sayı No	
	İS55	Pnömatik Piston Keçesi	NBR FKM FE	N 0175 F 0375 DS 37	16	-30 → +110 -30 → +225	≤ 1	49
	İS56	Kısa Tip Pnömatik Piston Keçesi	NBR FKM FE	N 0170 F 0370 DS 37	12	-30 → +110 -30 → +225	≤ 1	50
	İS58	Tek Yönlü Piston Keçesi	NBR FKM	N0190 F 0390	16	-30 → +110 -30 → +225	≤ 1	51
	İS51	X-Ring	NBR FKM	N 0170 F 0370	60	-30 → +110 -30 → +225	≤ 0,5	53
	İS52	Pnömatik Piston Keçesi	NBR FKM	N 0170 F 0370	12	-30 → +110 -30 → +225	≤ 1	55
	İS48	V-Ring A	NBR FKM	N 0165 F 0365	0,5	-30 → +110 -30 → +225	≤ 12	56
	İS49	V-Ring S	NBR FKM	N 0165 F 0365	0,5	-30 → +110 -30 → +225	≤ 12	57
	İS50	V-Ring L	NBR FKM	N 0165 F 0365	0,5	-30 → +110 -30 → +225	≤ 12	58
	İS61	Rod Omegat 1	NBR FKM PTFE	N 0170 F 0370 Br 0440	400	-30 → +110 -30 → +225	≤ 5	59
	İS64	Rod Döner Keçe	NBR FKM PTFE	N0170 F 0370 Br 0440	250	-30 → +110 -30 → +225	≤ 5	61
	İS63	U Yaylı PTFE Rod Keçesi	PTFE Yay	Cr 0625 C1/y 1245	350	-200 → +260	≤ 15	62

Profil	Kod	Açıklama	Malzeme	Basınç max (bar)	Isı max (°C)	Kayma Hızı	Sayı No	
	İS65	Pnömatik Toz Keçesi	NBR FKM PTFE	N 0165 F 0390 Br 0440	16	-30 → +225	≤ 1	63
	İS62	Rod Omegat 2	NBR FKM PTFE	N 0170 F 0370 Br 0440	400	-30 → +110 -30 → +225	≤ 2	64
	İS66	Rod Omegat 3	NBR FKM PTFE	N 0170 F 0370 Br 0440	400	-30 → +110 -30 → +225	≤ 2	65
	İS70	Piston Omegat 1	PTFE NBR FKM	Br 0440 N 0170 F 0370	400	-30 → +110 -30 → +225	≤ 5	66
	İS71	Tek Etkili Piston Omegat 2	PTFE NBR FKM	Br 0440 N 0170 F 0370	400	-30 → +110 -30 → +225	≤ 5	68
	İS72	Piston Omegat 3	PTFE NBR FKM	Br 0440 N 0170 F 0370	400	-30 → +110 -30 → +225	≤ 2	70
	İS73	Ağır Hizmet Piston Keçesi	FKM NBR PTFE PTFE POM	F 0380 N 0180 P 0310 Br 0440 PO 0005	400	-30 → +110 -30 → +225	≤ 1,5	71
	İS74	U Yaylı PTFE Piston Keçesi	PTFE Yay	Cr 0625 C1/y 1245	350	-200 → 260	≤ 15	72
	İS75	Piston Döner Keçe	NBR FKM PTFE	N0170 F 0370 Br 0440	250	-30 → +110 -30 → +225	≤ 5	73
	İS77	Segman Tip POM Omegat 4	NBR FKM POM	N 0170 F 0370 PO 0005	12	-30 → +110 -30 → +225	≤ 1	74
	İS78	PTFE Piston Omegat 5	NBR FKM PTFE	N 0170 F 0370 Cr 0625	12	-30 → +110 -30 → +225	≤ 1	75

Profil	Kod	Açıklama	Malzeme	Basınç max (bar)	Isı max (°C)	Kayma Hızı	Sayı No	
	İS38	PTFE Toz Keçesi	PTFE NBR FKM	Br 0440 N 0170 F 0370	-30 → +110 -30 → +225	≤ 5	76	
	İS39	PTFE Toz Keçesi	PTFE NBR FKM	Br 0440 N 0170 F 0370	-30 → +110 -30 → +225	≤ 5	77	
	İS40	PTFE Toz Keçesi	PTFE NBR FKM	Br 0440 N 0170 F 0370	-30 → +110 -30 → +225	≤ 5	79	
	İS110	EPDM/NBR Şerit O-Ring	NBR EPDM	N 0170 E 0180	63	-30 → +110 -40 → +140	≤ 0,5	80
	İS110	Silikon Şerit O-Ring	VMQ	V 0470	63	-60 → +200	≤ 0,5	81
	İS110	Silikon/NBR/FKM Şerit O-Ring (İthal)	NBR FKM VMQ	N 0170 F 0370 V 0470	63	-30 → +110 -30 → +225 -60 → +200	≤ 0,5	82
	İS 0	O-Ring	NBR FKM EPDM VMQ	N 0170 F 0370 E 0180 V 0470	63	-30 → +110 -30 → +225 -40 → +140 -60 → +200	≤ 0,5	83
	İS115	Kare Ring	NBR FKM VMQ	N 0170 F 0370 V 0470	63	-30 → +110 -30 → +225 -60 → +200	0,5	94
	İS80	Bronzlu PTFE Yataklama	PTFE	Br 0441		-50 → +225	≤ 15	100
	İS81	Karbonlu PTFE Yataklama	PTFE	Cr 0630		-50 → +225	≤ 15	101
	İS82	Polyester Resin Yataklama (İthal)	POLYESTER RESİN RS 0025	P/ RS 0025		-40 → +125	≤ 1	102

Profil	Kod	Açıklama	Malzeme	Basınç max (bar)	Isı max (°C)	Kayma Hızı	Sayfa No
	İS83	POM Ring Boğaz Yataklama	POM	Po 0006	-30 → +120	≤ 1	103
	İS87	Teleskopik Yataklama	POM	Po 0006	-30 → +120	≤ 1	104

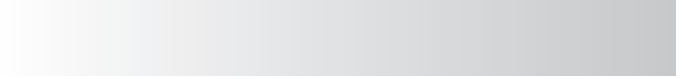

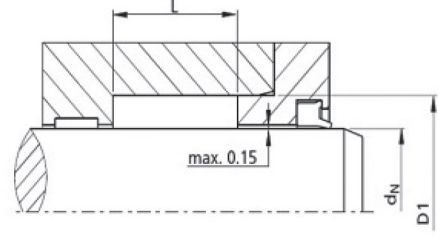
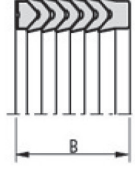
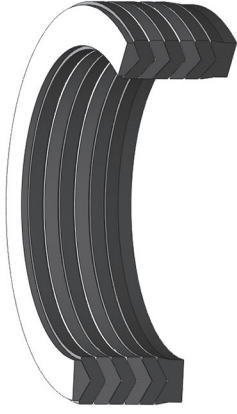

TAKIM KEÇELER İS1 - İS2 - İS4				
TİP	REF. NO	$\varnothing d$	$\varnothing D$	B
İS1	11-0008.0001	8	18	18,5
İS1	11-0010.0002	10	20	18,5
İS1	11-0012.0003	12	22	18,5
İS1	11-0014.0004	14	24	18,5
İS1	11-0015.0005	15	25	18,5
İS4	14-0015.0004	15,5	28	15
İS4	14-0015.0004	15,5	28	18
İS4	14-0015.0004	15,5	28	21
İS1	11-0016.0006	16	26	18,5
İS1	11-0018.0007	18	28	18,5
İS1	11-0020.0008	20	30	18,5
İS2	12-0020.0001	20	32	22,5
İS1	11-0022.0009	22	32	18,5
İS2	12-0022.0002	22	34	22,5
İS1	11-0025.0010	25	37	22,5
İS2	12-0025.0003	25	40	22,5
İS4	14-0025.0107	25,4	41,2	21,8
İS4	14-0025.0107	25,4	41,2	25,4
İS4	14-0025.0107	25,4	41,2	28,9
İS4	14-0028.0083	28	38	13,5
İS4	14-0028.0083	28	38	16
İS4	14-0028.0083	28	38	18,5
İS1	11-0028.0011	28	40	22,5
İS2	12-0028.0004	28	43	22,5
İS1	11-0030.0012	30	42	22,5
İS2	12-0030.0005	30	45	22,5
İS4	14-0032.0108	32	42	15
İS4	14-0032.0108	32	42	17,5
İS4	14-0032.0108	32	42	20
İS1	11-0032.0013	32	44	22,5
İS2	12-0032.0006	32	47	22,5

TAKIM KEÇELER İS1 - İS2 - İS4				
TİP	REF. NO	$\varnothing d$	$\varnothing D$	B
İS1	11-0035.0014	35	47	22,5
İS2	12-0035.0007	35	50	22,5
İS1	11-0036.0015	36	48	22,5
İS2	12-0036.0008	36	51	22,5
İS1	11-0040.0016	40	52	22,5
İS2	12-0040.0009	40	55	22,5
İS1	11-0042.0017	42	54	22,5
İS2	12-0042.0010	42	57	22,5
İS4	14-0045.0078	45	62	23
İS4	14-0045.0078	45	62	27
İS4	14-0045.0078	45	62	31
İS4	14-0045.0084	45	57	17,5
İS4	14-0045.0084	45	57	20
İS4	14-0045.0084	45	57	22,5
İS1	11-0045.0018	45	60	22,5
İS2	12-0045.0011	45	65	22,5
İS4	14-0050.0085	50	63	17,5
İS4	14-0050.0085	50	63	20
İS4	14-0050.0085	50	63	22,5
İS1	11-0050.0019	50	65	22,5
İS2	12-0050.0012	50	70	30
İS4	14-0050.0112	50,8	66,7	23,4
İS4	14-0050.0112	50,8	66,7	26,9
İS4	14-0050.0112	50,8	66,7	30,5
İS4	14-0051.0106	51	66	20
İS4	14-0051.0106	51	66	23,5
İS4	14-0051.0106	51	66	27
İS4	14-0051.0086	51	67	22,5
İS4	14-0051.0086	51	67	26
İS4	14-0051.0086	51	67	29,5
İS4	14-0052.0040	52	72	40

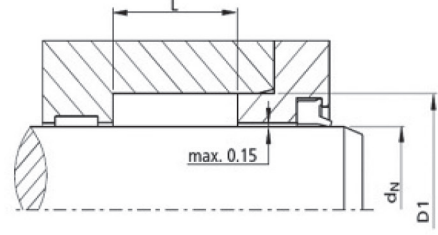
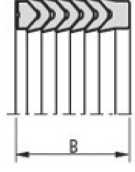
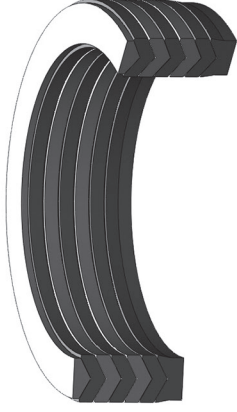

TAKIM KEÇELER İS1 - İS2 - İS4				
TİP	REF. NO	$\varnothing d$	$\varnothing D$	B
İS4	14-0052.0040	52	72	47,5
İS4	14-0052.0040	52	72	55
İS1	11-0055.0020	55	70	22,5
İS2	12-0055.0013	55	75	30
İS1	11-0056.0021	56	71	22,5
İS2	12-0056.0014	56	76	37
İS1	11-0060.0022	60	75	22,5
İS2	12-0060.0015	60	80	37
İS4	14-0062.0079	62	77	27
İS4	14-0062.0079	62	77	31
İS4	14-0062.0079	62	77	35
İS1	11-0063.0023	63	78	22,5
İS2	12-0063.0016	63	83	37
İS1	11-0065.0024	65	80	22,5
İS2	12-0065.0017	65	85	40
İS4	14-0070.0080	70	80	17,5
İS4	14-0070.0080	70	80	20
İS4	14-0070.0080	70	80	22,5
İS1	11-0070.0025	70	85	22,5
İS2	12-0070.0018	70	90	40
İS1	11-0075.0026	75	90	22,5
İS2	12-0075.0019	75	95	40
İS1	11-0080.0027	80	95	22,5
İS2	12-0080.0020	80	100	40
İS4	14-0080.0021	80	105	37,5
İS4	14-0080.0021	80	105	44
İS4	14-0080.0021	80	105	50,5
İS4	14-0082.0082	82	105	35
İS4	14-0082.0082	82	105	40
İS4	14-0082.0082	82	105	45
İS4	14-0082.0012	82	107	37

TAKIM KEÇELER İS1 - İS2 - İS4				
TİP	REF. NO	$\varnothing d$	$\varnothing D$	B
İS4	14-0082.0012	82	107	43,5
İS4	14-0082.0012	82	107	50
İS4	14-0082.0012	82,5	106	37
İS4	14-0082.0012	82,5	106	43,5
İS4	14-0082.0012	82,5	106	50
İS4	14-0082.0045	82,5	107,9	37
İS4	14-0082.0045	82,5	107,9	43
İS4	14-0082.0045	82,5	107,9	49
İS1	11-0085.0028	85	100	22,5
İS2	12-0085.0021	85	105	40
İS4	14-0085.0002	85	115	45
İS4	14-0085.0002	85	115	52,5
İS4	14-0085.0002	85	115	60
İS4	14-0088.0011	88,9	101,6	25,4
İS4	14-0088.0011	88,9	101,6	30,2
İS4	14-0088.0011	88,9	101,6	34,9
İS1	11-0090.0029	90	105	22,5
İS2	12-0090.0022	90	110	40
İS4	14-0095.0042	95	103	20
İS4	14-0095.0042	95	103	22,5
İS4	14-0095.0042	95	103	25
İS1	11-0100.0030	100	115	30
İS2	12-0100.0023	100	120	40
İS4	14-0108.0003	108	135	40
İS4	14-0108.0003	108	135	47
İS4	14-0108.0003	108	135	54
İS1	11-0110.0031	110	125	30
İS2	12-0110.0024	110	130	40
İS4	14-0110.0069	110	132	31,7
İS4	14-0110.0069	110	132	36,7
İS4	14-0110.0069	110	132	41,7

TAKIM KEÇELER İS1 - İS2 - İS4				
TİP	REF. NO	ø d	ø D	B
İS4	14-0110.0043	110	140	45
İS4	14-0110.0043	110	140	52,5
İS4	14-0110.0043	110	140	60
İS1	11-0115.0032	115	130	30
İS2	12-0115.0025	115	140	46
İS2	12-0120.0026	120	145	46
İS1	11-0125.0033	125	140	34
İS2	12-0125.0027	125	150	46
İS4	14-0125.0046	128	140	18
İS4	14-0125.0046	128	140	21
İS4	14-0125.0046	128	140	24
İS4	14-0130.0047	130	145	23,5
İS4	14-0130.0047	130	145	27,5
İS4	14-0130.0047	130	145	31,5
İS4	14-0130.0048	130	150	24
İS4	14-0130.0048	130	150	28
İS4	14-0130.0048	130	150	32
İS4	14-0135.0067	135	147	18
İS4	14-0135.0067	135	147	21
İS4	14-0135.0067	135	147	24
İS4	14-0135.0066	135	150	23,5
İS4	14-0135.0066	135	150	27,5
İS4	14-0135.0066	135	150	31,5
İS1	11-0140.0034	140	155	34
İS4	14-0140.0049	140	160	30
İS4	14-0140.0049	140	160	35
İS4	14-0140.0049	140	160	40
İS2	12-0140.0028	140	165	46
İS4	14-0140.0063	140	170	42,5
İS4	14-0140.0063	140	170	50
İS4	14-0140.0063	140	170	57,5
İS4	14-0145.0076	145	170	36
İS4	14-0145.0076	145	170	42
İS4	14-0145.0076	145	170	48
İS4	14-0145.0111	145	185	55
İS4	14-0145.0111	145	185	65
İS4	14-0145.0111	145	185	75
İS1	11-0150.0035	150	170	40
İS2	12-0150.0029	150	180	60
İS1	11-0160.0036	160	180	40
İS2	12-0160.0030	160	190	60
İS4	14-0162.0068	162	178	24

TAKIM KEÇELER İS1 - İS2 - İS4				
TİP	REF. NO	ø d	ø D	B
İS4	14-0162.0068	162	178	28
İS4	14-0162.0068	162	178	32
İS4	14-0175.0023	175	205	45
İS4	14-0175.0023	175	205	52,5
İS4	14-0175.0023	175	205	60
İS1	11-0180.0037	180	200	40
İS2	12-0180.0031	180	210	60
İS4	14-0190.0110	190	210	30
İS4	14-0190.0110	190	210	35
İS4	14-0190.0110	190	210	40
İS4	14-0190.0039	190	220	45
İS4	14-0190.0039	190	220	52,5
İS4	14-0190.0039	190	220	60
İS1	11-0200.0038	200	220	40
İS2	12-0200.0032	200	230	60
İS4	14-0210.0050	210	235	35
İS4	14-0210.0050	210	235	41
İS4	14-0210.0050	210	235	47
İS2	12-0210.0033	210	240	60
İS2	12-0215.0034	215	245	60
İS4	14-0215.0051	215	250	50
İS4	14-0215.0051	215	250	58,5
İS4	14-0215.0051	215	250	67
İS2	12-0225.0035	225	255	60
İS4	14-0228.0052	228	258	45
İS4	14-0228.0052	228	258	52,5
İS4	14-0228.0052	228	258	60
İS2	12-0230.0036	230	260	60
İS2	12-0240.0037	240	270	60
İS4	14-0250.0053	250	275	34
İS4	14-0250.0053	250	275	40
İS4	14-0250.0053	250	275	46
İS4	14-0250.0065	250	280	45
İS4	14-0250.0065	250	280	52,5
İS4	14-0250.0065	250	280	60
İS2	12-0250.0038	250	290	65
İS4	14-0260.0038	260	290	45
İS4	14-0260.0038	260	290	52,5
İS4	14-0260.0038	260	290	60
İS4	14-0272.0056	272,7	301	36
İS4	14-0272.0056	272,7	301	43
İS4	14-0272.0056	272,7	301	50

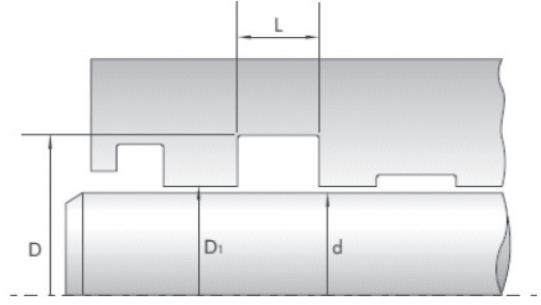
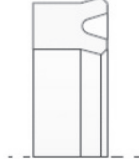

NUTRİNG KEÇE İS10				
TİP	REF. NO	$\emptyset d$	$\emptyset D$	B
İS10	20-0002.1348	2	7	4
İS10	20-0002.1287	2,8	5,8	2,3
İS10	20-0003.1374	3	6	2
İS10	20-0003.0522	3	7	4
İS10	20-0003.0331	3	7	5
İS10	20-0003.0515	3	8	2,2
İS10	20-0003.0705	3,5	6	2
İS10	20-0003.0311	3,5	10	4
İS10	20-0003.0312	3,5	12	4
İS10	20-0004.0953	4	6,5	2
İS10	20-0004.0749	4	7	2
İS10	20-0004.0002	4	7	2,5
İS10	20-0004.0829	4	7	2,75
İS10	20-0004.0839	4	7	3
İS10	20-0004.0972	4	7,5	2
İS10	20-0004.0254	4	7,5	2,8
İS10	20-0004.0841	4	7,5	3
İS10	20-0004.0356	4	7,5	3,5
İS10	20-0004.0332	4	7,5	4
İS10	20-0004.1244	4	7,5	4,3
İS10	20-0004.0704	4	7,8	2,3
İS10	20-0004.0829	4	8	2,5
İS10	20-0004.0635	4	8	2,8
İS10	20-0004.0231	4	8	3
İS10	20-0004.0974	4	8	3,5
İS10	20-0004.0500	4	9	3,5
İS10	20-0004.1320	4	10	3,5
İS10	20-0004.1216	4	10	5
İS10	20-0004.0276	4	11	4
İS10	20-0004.0114	4	11	4,7
İS10	20-0004.1587	4	12	4,3
İS10	20-0004.0448	4,5	7,2	2,8
İS10	20-0004.0113	4,5	9,5	4

NUTRİNG KEÇE İS10				
TİP	REF. NO	$\emptyset d$	$\emptyset D$	B
İS10	20-0004.0634	4,7	12,95	6
İS10	20-0005.0212	5	8	2
İS10	20-0005.0230	5	8	2,2
İS10	20-0005.0230	5	8	2,3
İS10	20-0005.0570	5	8	2,5
İS10	20-0005.0454	5	9,5	3,2
İS10	20-0005.1373	5	10	3,2
İS10	20-0005.0689	5	11	3
İS10	20-0005.1587	5	11	4
İS10	20-0005.0903	5	12	5
İS10	20-0005.0714	5	14	4
İS10	20-0005.0511	5	16	7
İS10	20-0005.0309	5,5	9,5	2,5
İS10	20-0005.0482	5,5	10,7	4
İS10	20-0005.0863	5,5	11	6,5
İS10	20-0005.0989	5,5	11,5	2
İS10	20-0005.1354	5,5	15,5	5
İS10	20-0006.0724	6	9	2
İS10	20-0006.0776	6	10	2
İS10	20-0006.0232	6	10	2,5
İS10	20-0006.0354	6	10	4
İS10	20-0006.0020	6	10	5
İS10	20-0006.0239	6	10,2	2,5
İS10	20-0006.0239	6	10,5	2,5
İS10	20-0006.1044	6	11	4
İS10	20-0006.0140	6	12	4,5
İS10	20-0006.0196	6	12	6,5
İS10	20-0006.0058	6	12,5	4
İS10	20-0006.0080	6	16	8
İS10	20-0006.0481	6	17,5	8
İS10	20-0006.0949	6	18	8
İS10	20-0006.0699	6	19	6
İS10	20-0006.0995	6	22	5

NUTRİNG KEÇE İS10				
TİP	REF. NO	ø d	ø D	B
İS10	20-0006.0329	6,35	12,7	4
İS10	20-0006.0327	6,3	12,8	3,7
İS10	20-0006.0449	6,5	9	2,5
İS10	20-0006.0572	6,5	9	3
İS10	20-0006.0710	6,5	12	4
İS10	20-0006.0609	6,5	12,5	3
İS10	20-0006.1626	6,5	12,5	3,5
İS10	20-0006.0153	6,5	13	3,5
İS10	20-0006.0167	6,5	15,5	5
İS10	20-0006.0193	6,5	16,5	10
İS10	20-0006.0527	6,5	19	3,5
İS10	20-0006.0586	6,7	10,5	3,5
İS10	20-0006.0539	6,8	13	4
İS10	20-0006.0223	6,9	14,76	5
İS10	20-0007.0063	7	10	2
İS10	20-0007.0262	7	11	2,5
İS10	20-0007.0709	7	11	3
İS10	20-0007.0830	7	12	2,5
İS10	20-0007.0272	7	12	5
İS10	20-0007.0677	7	12,5	4
İS10	20-0007.0793	7	12,5	5
İS10	20-0007.0516	7	13	2,5
İS10	20-0007.0146	7	13,5	4,5
İS10	20-0007.0345	7	14	3,5
İS10	20-0007.0823	7	15	5
İS10	20-0007.0901	7	15	6
İS10	20-0007.0800	7	17	10
İS10	20-0007.0914	7,5	10	2,2
İS10	20-0007.0432	7,5	13,5	4
İS10	20-0007.0532	7,5	14,5	4
İS10	20-0007.0091	7,62	14,76	5
İS10	20-0007.0436	7,8	12	2,5
İS10	20-0007.0849	7,8	13,5	2,5
İS10	20-0008.0520	8	12	4,5
İS10	20-0008.0662	8	12	5
İS10	20-0008.1375	8	13	2,5
İS10	20-0008.0982	8	13	3
İS10	20-0008.1316	8	13	4
İS10	20-0008.1337	8	14	3
İS10	20-0008.0431	8	14	4
İS10	20-0008.1456	8	14	5
İS10	20-0008.0086	8	14	6,5
İS10	20-0008.1585	8	16	4
İS10	20-0008.0379	8	16	6

NUTRİNG KEÇE İS10				
TİP	REF. NO	ø d	ø D	B
İS10	20-0008.0216	8	17	8
İS10	20-0008.0676	8	18	6
İS10	20-0008.0699	8	19	6
İS10	20-0008.0782	8	20	10
İS10	20-0008.0251	8	21	8
İS10	20-0008.0078	8,5	10,5	2
İS10	20-0008.0523	8,5	11	2
İS10	20-0008.0242	8,5	12,5	2,7
İS10	20-0008.0625	8,5	12,5	7
İS10	20-0008.0677	8,5	13	7
İS10	20-0008.0179	8,5	14	7
İS10	20-0008.0000	8,5	15	6
İS10	20-0008.0921	8,5	16,5	5,5
İS10	20-0009.0669	9	12	2
İS10	20-0009.0346	9	12	2,2
İS10	20-0009.0517	9	14	2,5
İS10	20-0009.0615	9	14	4
İS10	20-0009.1221	9	16	4
İS10	20-0009.1614	9	16	6
İS10	20-0009.0746	9	18	4,5
İS10	20-0009.1260	9,25	16,3	3,75
İS10	20-0009.0093	9,5	11,5	2
İS10	20-0009.0910	9,5	14,5	2,5
İS10	20-0009.0180	9,5	16	6
İS10	20-0009.0021	9,5	17	8
İS10	20-0009.0012	9,7	14	4
İS10	20-0009.0463	9,7	14,5	2,8
İS10	20-0009.0071	9,8	16	3,2
İS10	20-0010.0132	10	13	2,2
İS10	20-0010.0294	10	13,5	3,7
İS10	20-0010.1307	10	14	3
İS10	20-0010.0504	10	15	2,5
İS10	20-0010.0283	10	15	3,5
İS10	20-0010.0341	10	16	2,5
İS10	20-0010.1318	10	16	2,7
İS10	20-0010.1257	10	16	3
İS10	20-0010.0936	10	16	3,5
İS10	20-0010.1566	10	16	4
İS10	20-0010.1219	10	16	4,25
İS10	20-0010.0200	10	16	4,5
İS10	20-0010.1315	10	16	4,75
İS10	20-0010.0958	10	16	5
İS10	20-0010.0479	10	16	6
İS10	20-0010.0199	10	16	8

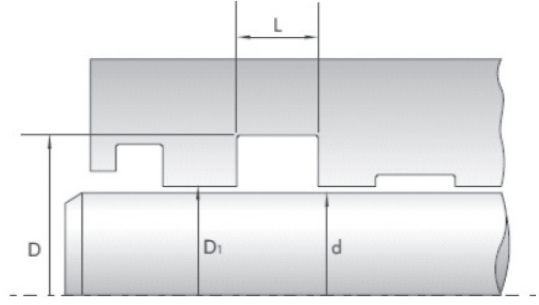
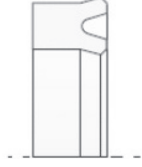

NUTRİNG KEÇE İS10				
TİP	REF. NO	ø d	ø D	B
İS10	20-0010.0135	10	18	4,5
İS10	20-0010.1181	10	18	5,5
İS10	20-0010.1363	10	19	5,5
İS10	20-0010.0891	10	19	6,5
İS10	20-0010.0751	10	19	7
İS10	20-0010.0316	10	20	3
İS10	20-0010.0215	10	20	4
İS10	20-0010.0382	10	20	5
İS10	20-0010.0001	10	20	8
İS10	20-0010.0317	10	22	4,5
İS10	20-0010.0226	10	22	6
İS10	20-0010.0543	10	25	3
İS10	20-0010.0430	10	32	10
İS10	20-0010.0540	10,2	13,5	1,80
İS10	20-0010.0068	10,2	15	3
İS10	20-0010.0148	10,3	15	3,5
İS10	20-0010.0001	10,5	14,2	3
İS10	20-0011.0724	11	14	3
İS10	20-0011.0083	11	15	3
İS10	20-0011.0299	11	16,5	3,2
İS10	20-0011.1238	11	17,5	3,5
İS10	20-0011.0447	11	18	5
İS10	20-0011.0777	11	21	5
İS10	20-0011.0257	11	24	7
İS10	20-0011.1021	11,10	15,90	2,3
İS10	20-0011.0154	11,5	16	3,5
İS10	20-0012.0633	12	16,5	3
İS10	20-0012.1187	12	17	3,5
İS10	20-0012.0964	12	18	2,5
İS10	20-0012.0149	12	18	2,8
İS10	20-0012.1397	12	18	3
İS10	20-0012.0133	12	18,5	4,5
İS10	20-0012.1370	12	20	5,5

NUTRİNG KEÇE İS10				
TİP	REF. NO	ø d	ø D	B
İS10	20-0012.0712	12	20	6
İS10	20-0012.0022	12	20	8
İS10	20-0012.0225	12	20	10
İS10	20-0012.0002	12	22	8
İS10	20-0012.0906	12	24	7
İS10	20-0012.0674	12	25	10
İS10	20-0012.0142	12	26	8
İS10	20-0012.0210	12	28	8
İS10	20-0012.1172	12	28	10
İS10	20-0012.0087	12,3	17,8	5,3
İS10	20-0012.0087	12,3	17,86	2,5
İS10	20-0012.0282	12,5	17,5	4,5
İS10	20-0012.0281	12,5	17,5	6
İS10	20-0012.0253	12,5	22	6,5
İS10	20-0013.0127	13	17	2,7
İS10	20-0013.0444	13	19	2,5
İS10	20-0013.0783	13	19	4,5
İS10	20-0013.0319	13	20,5	5
İS10	20-0013.0606	13	23	6
İS10	20-0013.0310	13	25	4
İS10	20-0013.0302	13,5	21,5	5
İS10	20-0013.0773	13,5	23,5	6
İS10	20-0014.0438	14	18	2,8
İS10	20-0014.0484	14	19,5	3,5
İS10	20-0014.0681	14	20	2,5
İS10	20-0014.0268	14	20	4
İS10	20-0014.0435	14	20	4,5
İS10	20-0014.0059	14	20	5
İS10	20-0014.1600	14	20	8
İS10	20-0014.0195	14	21	8
İS10	20-0014.0339	14	24	7
İS10	20-0014.0003	14	24	8
İS10	20-0014.0680	14	26	7

NUTRİNG KEÇE İS10				
TİP	REF. NO	ø d	ø D	B
İS10	20-0014.1444	14	28	7,5
İS10	20-0014.1422	14	28	8
İS10	20-0014.0443	14,5	20	2,5
İS10	20-0014.1257	14,5	20	3
İS10	20-0014.0076	14,5	20	4
İS10	20-0014.0425	14,5	20	5
İS10	20-0015.0065	15	19,5	3
İS10	20-0015.0573	15	20	3
İS10	20-0015.0028	15	20	4
İS10	20-0015.0552	15	20	5
İS10	20-0015.0473	15	21	2
İS10	20-0015.0476	15	21	3,5
İS10	20-0015.0665	15	21	6,5
İS10	20-0015.1264	15	21	7
İS10	20-0015.0181	15	23	6
İS10	20-0015.0218	15	23	10
İS10	20-0015.1309	15	25	5
İS10	20-0015.1222	15	25	6
İS10	20-0015.1527	15	25	7
İS10	20-0015.0004	15	25	8
İS10	20-0015.0676	15	25	10
İS10	20-0015.0077	15,5	21,5	5,2
İS10	20-0015.0045	15,8	22,2	4,74
İS10	20-0015.0351	15,87	25,4	4
İS10	20-0016.1408	16	20	2,7
İS10	20-0016.0165	16	21	2,6
İS10	20-0016.0666	16	21	3
İS10	20-0016.0592	16	21	4
İS10	20-0016.0656	16	21	5
İS10	20-0016.0353	16	21	6
İS10	20-0016.0895	16	22	3
İS10	20-0016.0692	16	22	4
İS10	20-0016.1156	16	22	5
İS10	20-0016.0707	16	22	6
İS10	20-0016.0263	16	24	4,5
İS10	20-0016.1371	16	24	5,5
İS10	20-0016.0000	16	24	7
İS10	20-0016.1196	16	25	7
İS10	20-0016.0426	16	26	5
İS10	20-0016.0636	16	26	5,5
İS10	20-0016.1584	16	26	6
İS10	20-0016.1358	16	26	6,5
İS10	20-0016.0005	16	26	8
İS10	20-0016.0781	16	28	7

NUTRİNG KEÇE İS10				
TİP	REF. NO	ø d	ø D	B
İS10	20-0016.0051	16	28	7,5
İS10	20-0016.0452	16	29	9
İS10	20-0016.0000	16	32	8
İS10	20-0016.0612	16,5	22,5	4
İS10	20-0016.0090	16,5	23,5	5
İS10	20-0016.0608	16,7	26,7	8
İS10	20-0017.1197	17	21	3
İS10	20-0017.0732	17	23	5
İS10	20-0017.0157	17	24	4,5
İS10	20-0017.0537	17	24	5,5
İS10	20-0017.0725	17	27	7
İS10	20-0017.0013	17	28	7
İS10	20-0017.0599	17	30	10
İS10	20-0017.0568	17	33	9,5
İS10	20-0017.0122	17	40	10
İS10	20-0017.1201	17,4	28,6	6,7
İS10	20-0017.0233	17,46	25,4	6,35
İS10	20-0018.0897	18	22	3
İS10	20-0018.0321	18	24	3,8
İS10	20-0018.0564	18	24	5
İS10	20-0018.0936	18	25	4
İS10	20-0018.0501	18	25	5
İS10	20-0018.1301	18	25	5,5
İS10	20-0018.0610	18	26	4
İS10	20-0018.0168	18	26	4,5
İS10	20-0018.1265	18	26	5
İS10	20-0018.0637	18	26	5,5
İS10	20-0018.0384	18	26	6
İS10	20-0018.0380	18	28	5,5
İS10	20-0018.0748	18	28	6
İS10	20-0018.0006	18	28	8
İS10	20-0018.0184	18	30	7,5
İS10	20-0018.0698	18,5	23,5	5
İS10	20-0019.0840	19	24	3,2
İS10	20-REF.0723	19	24	5
İS10	20-0019.1255	19	24	7
İS10	20-0019.0595	19	25	2
İS10	20-0019.0681	19	25	3
İS10	20-0019.0785	19	26	2,5
İS10	20-0019.1043	19	26	5
İS10	20-0019.0856	19	26,5	3
İS10	20-0019.0918	19	30	9
İS10	20-0019.0066	19,05	28,1	4,52
İS10	20-0019.0145	19,05	28,6	6,35

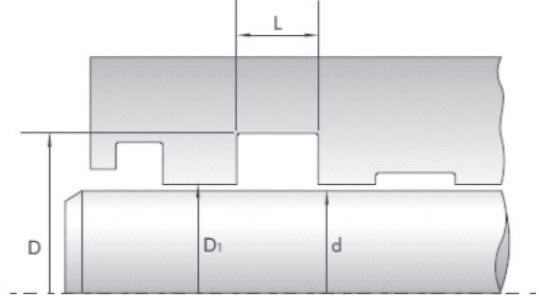
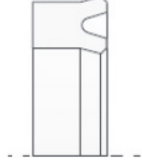

NUTRİNG KEÇE İS10				
TİP	REF. NO	$\emptyset d$	$\emptyset D$	B
İS10	20-0019.1003	19,05	31,6	6,35
İS10	20-0019.0779	19,5	25	3
İS10	20-0019.0138	19,5	26	4
İS10	20-0019.0143	19,5	29	5
İS10	20-0019.0637	19,5	29,5	5
İS10	20-0019.0070	19,5	30,8	6,5
İS10	20-0019.0111	19,8	25,4	3,2
İS10	20-0020.0750	20	24	3
İS10	20-0020.0696	20	25	5
İS10	20-0020.1038	20	26	5
İS10	20-0020.0888	20	26	4,5
İS10	20-0020.1567	20	26	5,5
İS10	20-0020.0778	20	27	4,5
İS10	20-0020.0855	20	28	3
İS10	20-0020.0887	20	28	5
İS10	20-0020.0000	20	28	5,5
İS10	20-0020.0453	20	28	8
İS10	20-0020.0164	20	30	6
İS10	20-0020.0007	20	30	8
İS10	20-0020.1312	20	32	3,5
İS10	20-0020.0781	20	32	7
İS10	20-0020.0857	20	32	8
İS10	20-0020.0784	20	32,7	9,5
İS10	20-0020.0660	20	32,7	11,5
İS10	20-0020.0553	20	33	10
İS10	20-0020.1155	20	38	4,1
İS10	20-0020.0000	20	40	10
İS10	20-0020.0370	20,2	28,6	4,35
İS10	20-0020.0125	20,35	25	3
İS10	20-0020.0664	20,5	27,5	5
İS10	20-0021.0334	21	25	2,5
İS10	20-0021.0917	21	25	2,7
İS10	20-0021.0658	21	25	3

NUTRİNG KEÇE İS10				
TİP	REF. NO	$\emptyset d$	$\emptyset D$	B
İS10	20-0021.0110	21	26,5	3,2
İS10	20-0021.1196	21	29,5	6,5
İS10	20-0021.0959	21	32	6
İS10	20-0021.0562	21	35	5,5
İS10	20-0021.0376	21	53	14
İS10	20-0022.0073	22	25	3
İS10	20-0022.0673	22	26	3
İS10	20-0022.1190	22	27	6
İS10	20-0022.1045	22	28	3
İS10	20-0022.0000	22	28	3,3
İS10	20-0022.0747	22	29	5
İS10	20-0022.0328	22	30	4
İS10	20-0022.1355	22	30	5
İS10	20-0022.0286	22	30	5,5
İS10	20-0022.1382	22	30	6
İS10	20-0022.0300	22	30	7
İS10	20-0022.1242	22	31	5
İS10	20-0022.0047	22	32	5
İS10	20-0022.0288	22	32	6
İS10	20-0022.0008	22	32	8
İS10	20-0022.0559	22	37	5
İS10	20-0022.0144	22,5	28,5	3,5
İS10	20-0022.0252	22,5	28,5	4
İS10	20-0022.0478	22,5	32,2	7,3
İS10	20-0023.0211	23	32	2,8
İS10	20-0023.0014	23	32	4
İS10	20-0023.0894	23	35	6
İS10	20-0023.0607	23,5	29,5	4,5
İS10	20-0023.0911	23,5	30,5	5,8
İS10	20-0024.0621	24	28	5,4
İS10	20-0024.0576	24	29	3
İS10	20-0024.1000	24	30	4,5
İS10	20-0024.0790	24	31	3,5

NUTRİNG KEÇE İS10				
TİP	REF. NO	ø d	ø D	B
İS10	20-0024.0277	24	32	3,2
İS10	20-0024.0506	24	32	4
İS10	20-0024.1346	24	32	4,5
İS10	20-0024.0170	24	32	5
İS10	20-0024.0956	24	32	5,5
İS10	20-0024.0392	24	32	6
İS10	20-0024.1163	24	34	5
İS10	20-0024.0600	24,5	36,5	10
İS10	20-0025.1188	25	30	4,5
İS10	20-0025.0227	25	32	6
İS10	20-0025.0214	25	33	4
İS10	20-0025.0084	25	33	5
İS10	20-0025.0498	25	33	6
İS10	20-0025..0594	25	33	7
İS10	20-0025.0807	25	34	8
İS10	20-0025.0942	25	35	5
İS10	20-0025.0973	25	35	6
İS10	20-0025.0105	25	35	8
İS10	20-0025.0442	25	37	6
İS10	20-0025.0587	25	40	6
İS10	20-0025.0675	25	40	8
İS10	20-0025.0009	25	40	10
İS10	20-0025.1506	25	40	10,5
İS10	20-0025.0770	25	42	8,5
İS10	20-0025.0541	25	50	15
İS10	20-0025.1031	25	50	20
İS10	20-0025.0259	25	50	25
İS10	20-0025.0305	25,4	30,8	6,35
İS10	20-0025.1157	25,4	33,1	6,35
İS10	20-0025.0992	25,5	35	6,5
İS10	20-0025.0686	25,5	37	10
İS10	20-0026.1616	26	34	4,5
İS10	20-0026.0556	26	34	6
İS10	20-0026.0627	26	34	7
İS10	20-0026.0700	26	35	6
İS10	20-0026.0224	26	36	5,7
İS10	20-0026.0902	26	37	6,5
İS10	20-0026.0905	26	38	4
İS10	20-0026.0024	26	38	6
İS10	20-0026.0943	26	38	10
İS10	20-0026.0115	26	39	6,3
İS10	20-0026.0096	26	39	6,8
İS10	20-0026.0266	26	40	10
İS10	20-0026.0000	27	32	3

NUTRİNG KEÇE İS10				
TİP	REF. NO	ø d	ø D	B
İS10	20-0027.0589	27	35	3,5
İS10	20-0027.1283	27	35	5
İS10	20-0027.0670	27	35	8
İS10	20-0027.1189	27	37	4
İS10	20-0027.0548	27	37	6
İS10	20-0027.0703	27	37	7
İS10	20-0027.1028	27	37	8
İS10	20-0027.0690	27	37	10
İS10	20-0027.0377	27	39	6
İS10	20-0027.0270	27,5	39	6,3
İS10	20-0028.1635	28	33	3,2
İS10	20-0028.1224	28	34	6
İS10	20-0028.0267	28	35	6,5
İS10	20-0028.0904	28	36	5
İS10	20-0028.0256	28	38	5
İS10	20-0028.1382	28	38	6
İS10	20-0028.0861	28	38	7
İS10	20-0028.0688	28	38	10
İS10	20-0028.0605	28	40	6
İS10	20-0028.0386	28	40	7
İS10	20-0028.0817	28	42	6
İS10	20-0028.0010	28	43	10
İS10	20-0028.0388	28	48	12
İS10	20-0029.0799	29	49	10
İS10	20-0030.1175	30	36	3
İS10	20-0030.0003	30	38	4
İS10	20-0030.0736	30	38	5
İS10	20-0030.0596	30	39	7,5
İS10	20-0030.0933	30	40	3
İS10	20-0030.0772	30	40	5
İS10	20-0030.0711	30	40	5,5
İS10	20-0030.0854	30	40	6
İS10	20-0030.0373	30	40	7
İS10	20-0030.1007	30	40	8
İS10	20-0030.0701	30	40	10
İS10	20-0030.1262	30	41	4,2
İS10	20-0030.0754	30	42	7
İS10	20-0030.0389	30	43	7
İS10	20-0030.0258	30	43	8
İS10	20-0030.0261	30	43	10
İS10	20-0030.0451	30	45	6
İS10	20-0030.0754	30	45	8
İS10	20-0030.0011	30	45	10
İS10	20-0030.1356	30	45	12

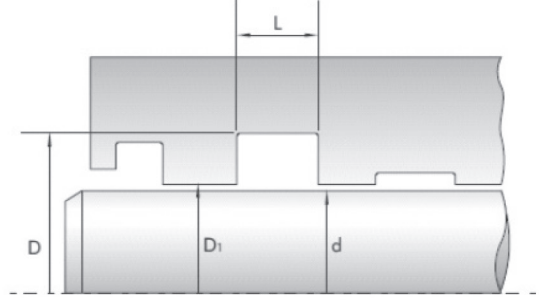
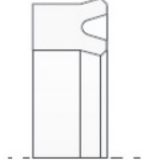

NUTRİNG KEÇE İS10				
TİP	REF. NO	$\emptyset d$	$\emptyset D$	B
İS10	20-0030.0691	30	47	8
İS10	20-0030.0789	30	47	9
İS10	20-0030.0987	30	47	10
İS10	20-0030.0000	30	50	10
İS10	20-0030.0850	30	52	7
İS10	20-0030.1235	30,16	38,10	6,35
İS10	20-0030.0050	30,5	36	3
İS10	20-0030.1352	30,7	42,4	9
İS10	20-0031.0542	31	39	3
İS10	20-0031.1254	31	40	5
İS10	20-0031.0000	31	41	4,5
İS10	20-0031.1300	31	42	6
İS10	20-0031.0508	31	45	7
İS10	20-0031.0293	31,5	39,5	3
İS10	20-0031.0303	31,5	41,5	5
İS10	20-0031.0791	31,5	41,5	6
İS10	20-0032.0567	32	40	3
İS10	20-0032.0477	32	40	3,5
İS10	20-0032.0590	32	40	5
İS10	20-0032.0954	32	40	8
İS10	20-0032.1012	32	42	7
İS10	20-0032.0575	32	42	8
İS10	20-0032.0930	32	42	9
İS10	20-0032.0999	32	42	10
İS10	20-0032.0722	32	44	7
İS10	20-0032.0657	32	44	8
İS10	20-0032.0892	32	45	6
İS10	20-0032.0000	32	45	7,95
İS10	20-0032.1583	32	47	10
İS10	20-0032.0931	32	48	3
İS10	20-0032.0234	32,5	47,5	8
İS10	20-0033.0213	33	40	3,2
İS10	20-0033.0561	33	40	8

NUTRİNG KEÇE İS10				
TİP	REF. NO	$\emptyset d$	$\emptyset D$	B
İS10	20-0033.1308	33	40	9,5
İS10	20-0033.0585	33	49	10
İS10	20-0033.0046	33,5	43,5	8
İS10	20-0034.0235	34	40	4,5
İS10	20-0034.0100	34	42	4,2
İS10	20-0034.1535	34	47	8
İS10	20-0034.0497	34	46	8
İS10	20-0034.0809	34	48	10
İS10	20-0035.0304	35	40	3
İS10	20-0035.01408	35	40	4,2
İS10	20-0035.0496	35	42	4,5
İS10	20-0035.1325	35	43	4,5
İS10	20-0035.0011	35	43	5
İS10	20-0035.0197	35	43	5,5
İS10	20-0035.1013	35	43	6,5
İS10	20-0035.1608	35	43	7
İS10	20-0035.0428	35	43,5	6
İS10	20-0035.1539	35	44	5
İS10	20-0035.0264	35	44	5,5
İS10	20-0035.0659	35	44	7,5
İS10	20-0035.1193	35	45	5
İS10	20-0035.0342	35	45	6
İS10	20-0035.0702	35	45	7
İS10	20-0035.1269	35	45	7,2
İS10	20-0035.1586	35	45	8
İS10	20-0035.0174	35	45	10
İS10	20-0035.0241	35	46,5	3,5
İS10	20-0035.1324	35	47	7
İS10	20-0035.0285	35	48	8
İS10	20-0035.0886	35	48	8,7
İS10	20-0035.0060	35	50	8
İS10	20-0035.0445	35	50	9
İS10	20-0035.0013	35	50	10

NUTRİNG KEÇE İS10				
TİP	REF. NO	ø d	ø D	B
İS10	20-0035.0203	35	52	10
İS10	20-0035.0247	35	62	8
İS10	20-0036.0265	36	42	5,5
İS10	20-0036.1607	36	44	4,5
İS10	20-0036.1019	36	44	5
İS10	20-0036.0000	36	44	5,2
İS10	20-0036.0851	36	44	7,3
İS10	20-0036.1601	36	45	8
İS10	20-0036.0899	36	46	5
İS10	20-0036.0853	36	46	7
İS10	20-0036.1165	36	46	8
İS10	20-0036.0687	36	47	4
İS10	20-0036.0951	36	47	8
İS10	20-0036.1299	36	48	10
İS10	20-0036.0367	36	50	8,7
İS10	20-0036.1239	36,51	50,8	7,93
İS10	20-0036.0827	36	50	10
İS10	20-0036.0014	36	51	10
İS10	20-0036.0821	36,5	48	6,5
İS10	20-0037.1173	37	45	3,3
İS10	20-0037.0557	37	45	4
İS10	20-0037.0842	37	49	6,5
İS10	20-0038.0559	38	47	4,5
İS10	20-0038.1611	38	48	5
İS10	20-0038.1302	38	48	6
İS10	20-0038.0343	38	50	6
İS10	20-0038.1526	38	50	7
İS10	20-0038.1217	38	50	7,5
İS10	20-0038.1023	38	50	8
İS10	20-0038.0663	38	50	9
İS10	20-0038.0624	38	55	10
İS10	20-0038.0639	38,5	47,5	9,5
İS10	20-0039.0495	39	47,3	4
İS10	20-0039.0591	39	48	7,5
İS10	20-0040.0980	40	48	6
İS10	20-0040.0291	40	48	6,8
İS10	20-0040.0187	40	48	10
İS10	20-0040.0457	40	50	4
İS10	20-0040.1026	40	50	5
İS10	20-0040.0932	40	50	6
İS10	20-0040.0638	40	50	6,5
İS10	20-0040.1162	40	50	7
İS10	20-0040.0338	40	50	8
İS10	20-0040.0151	40	50	10

NUTRİNG KEÇE İS10				
TİP	REF. NO	ø d	ø D	B
İS10	20-0040.0884	40	51	6,3
İS10	20-0040.0623	40	54	5
İS10	20-0040.0735	40	55	10
İS10	20-0040.0767	40	56	12
İS10	20-0040.1401	40	60	10
İS10	20-0040.1233	40	62	12
İS10	20-0041.01409	41	51	4,7
İS10	20-0041.0816	41	56	8
İS10	20-0041.0832	41,28	50,8	6
İS10	20-0041.0236	41,5	48,5	3,2
İS10	20-0042.0275	42	47	4,2
İS10	20-0042.0672	42	50	3,3
İS10	20-0042.1234	42	50	5
İS10	20-0042.1002	42	50	5,5
İS10	20-0042.0563	42	50	8
İS10	20-0042.0000	42	50,5	4,8
İS10	20-0042.0971	42	51	9
İS10	20-0042.0240	42	51	10
İS10	20-0042.0797	42	61	12,5
İS10	20-0042.0245	42	62	8
İS10	20-0042.0301	42,5	50,5	6
İS10	20-0042.1381	42,5	55	7
İS10	20-0043.0509	43	48	4,5
İS10	20-0043.0631	43	51	3
İS10	20-0043.0628	43	51	8
İS10	20-0043.0188	43	52	5
İS10	20-0043.0788	43	58	6
İS10	20-0043.0668	43	64	8
İS10	20-0044.0810	44	56	6,5
İS10	20-0044.0420	44,45	53,96	5,5
İS10	20-0045.1606	45	53	4,5
İS10	20-0045.1590	45	53	6
İS10	20-0045.0916	45	54	5
İS10	20-0045.0565	45	54	9,5
İS10	20-0045.0472	45	55	5
İS10	20-0045.0474	45	55	6
İS10	20-0045.0544	45	55	7
İS10	20-045.1040	45	55	8
İS10	20-0045.0186	45	55	10
İS10	20-0045.1369	45	58	10
İS10	20-0045.0733	45	60	3
İS10	20-0045.0361	45	60	8
İS10	20-0045.0016	45	60	10
İS10	20-0045.0171	45	60	12

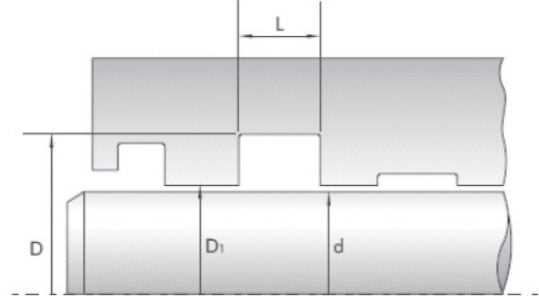
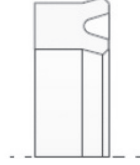

NUTRİNG KEÇE İS10				
TİP	REF. NO	$\varnothing d$	$\varnothing D$	B
İS10	20-0045.1191	45	80	10
İS10	20-0046.0551	46	53	12
İS10	20-0046.0159	46	54	12
İS10	20-0047.0494	47	62	10
İS10	20-0048.0603	48	56	5
İS10	20-0048.1620	48	58	4
İS10	20-0048.0000	48	58	6,5
İS10	20-0048.0191	48	58	10
İS10	20-0048.1303	48	62	8
İS10	20-0048.0107	48	63	10
İS10	20-0049.1194	49	56	11
İS10	20-0050.1321	50	58	8
İS10	20-0050.0335	50	60	6
İS10	20-0050.0352	50	60	7
İS10	20-0050.0566	50	60	8
İS10	20-0050.0363	50	60	10
İS10	20-0050.0287	50	60	13
İS10	20-0050.0137	50	62	7,5
İS10	20-0050.0480	50	62,5	8
İS10	20-0050.1020	50	63	8
İS10	20-0050.0387	50	63	9
İS10	20-0050.0273	50	63	10
İS10	20-0050.0667	50	65	7
İS10	20-0050.0182	50	65	7,5
İS10	20-0050.0106	50	65	10
İS10	20-0050.0017	50	70	10
İS10	20-0050.0000	50	70	11
İS10	20-0050.0172	50	70	12
İS10	2.000.501.610	50	75	14,5
İS10	20-0050.0983	50	80	10
İS10	20-0050.1161	50,8	57,15	4,5
İS10	20-0050.0900	50,8	60,3	4,75
İS10	20-0050.0000	50,8	60,3	9

NUTRİNG KEÇE İS10				
TİP	REF. NO	$\varnothing d$	$\varnothing D$	B
İS10	20-0050.0991	50,8	63,5	9,5
İS10	20-0050.0308	50,8	72,2	5,3
İS10	20-0051.0994	51	60	4,5
İS10	20-0051.0843	51	60	6,5
İS10	20-0051.0437	51	63	3,7
İS10	20-0051.0307	51	63	7
İS10	20-0051.0109	51	63	10
İS10	20-0051.0249	51,5	66,5	7,5
İS10	20-0052.0601	52	61	8
İS10	20-0052.0166	52	62	4,2
İS10	20-0052.0981	52	62	7
İS10	20-0052.0085	52,4	63,5	6
İS10	20-0053.0072	53	62	4
İS10	20-0053.0533	53	63	4
İS10	20-0053.1319	53	63	4,5
İS10	20-0053.0952	53	63	6
İS10	20-0053.0371	53	63	7
İS10	20-0053.0255	53	63	8
İS10	20-0053.0008	53	65	8
İS10	20-0053.0950	53	67	10
İS10	20-0053.1350	53	67,5	9
İS10	20-0053.1617	53	69	7
İS10	20-0053.0295	53,5	62,5	10
İS10	20-0053.0044	53,97	63,5	6,35
İS10	20-0054.0597	54	59	7
İS10	20-0054.0485	54	60	5
İS10	20-0054.0833	54	62	4,5
İS10	20-0054.1618	54	64	4,5
İS10	20-0054.1164	54	64	5,5
İS10	20-0054.0419	54	69	7,5
İS10	20-0054.0529	54	69	9
İS10	20-0054.1381	54	70	8
İS10	20-0054.1024	54	73	6,5

NUTRİNG KEÇE İS10				
TİP	REF. NO	ø d	ø D	B
İS10	20-0054.0919	54,5	63,5	5
İS10	20-0054.0502	54,5	64	4
İS10	20-0055.0423	55	65	4
İS10	20-0055.0385	55	65	8
İS10	20-0055.0000	55	65	12
İS10	20-0055.0000	55	67	8
İS10	20-0055.0104	55	70	10
İS10	20-0055.0826	55	75	10
İS10	20-0055.0018	55	75	12
İS10	20-0050.0000	55	80	10
İS10	20-0056.0169	56	65	5
İS10	20-0056.0752	56	66	5
İS10	20-0056.1406	56	66	10
İS10	20-0056.0000	56	68	8,5
İS10	20-0056.1402	56	71	6,3
İS10	20-0056.1334	56	71	10
İS10	20-0056.1404	56	76	10
İS10	20-0056.1403	56	76	12
İS10	20-0057.0915	57	63	8
İS10	20-0057.1004	57	90	8,73
İS10	20-0058.0459	58	68	5
İS10	20-0058.0000	58	68	8
İS10	20-0058.0101	58	76,2	7,73
İS10	20-0059.0136	59,5	67,5	7
İS10	20-0060.0429	60	68	8
İS10	20-0060.0433	60	69	4
İS10	20-0060.0811	60	70	6
İS10	20-0060.0907	60	70	8
İS10	20-0060.1392	60	70	10
İS10	20-0060.0000	60	74	8
İS10	20-0060.0881	60	75	7
İS10	20-0060.0034	60	75	8
İS10	20-0060.0890	60	75	9
İS10	20-0060.0116	60	75	10
İS10	20-0060.0640	60	75	12,5
İS10	20-0060.0593	60	76	12,5
İS10	20-0060.0117	60	80	7
İS10	20-0060.0000	60	80	10
İS10	20-0060.0019	60	80	12
İS10	20-0060.0944	60	80	20
İS10	20-0060.0000	60	85	10
İS10	20-0060.0641	60,5	69,5	6
İS10	20-0061.0503	61	69	7
İS10	20-0062.0340	62	80	8

NUTRİNG KEÇE İS10				
TİP	REF. NO	ø d	ø D	B
İS10	20-0060.0000	54	63	4,5
İS10	20-0063.0547	63	75	8
İS10	20-0063.0369	63	78	8
İS10	20-0063.0000	63	78	10
İS10	20-0063.0020	63	83	12
İS10	20-0063.0898	63,5	73,2	6,35
İS10	20-0063.0039	63,5	76,2	7,93
İS10	20-0063.0033	63,5	76,2	9,92
İS10	20-0063.0173	63,5	76,2	14,28
İS10	20-0064.0661	64	71,5	11,5
İS10	20-0064.1014	64	76	6
İS10	20-0064.1322	64	76	6,5
İS10	20-0064.0957	64	77	7
İS10	20-0064.0250	64	79	6
İS10	20-0064.0102	64	80	12
İS10	20-0065.0313	65	72	3
İS10	20-0065.1005	65	73	6
İS10	20-0065.0246	65	73	8
İS10	20-0065.0740	65	75	5
İS10	20-0065.0588	65	79	9,5
İS10	20-0065.1525	65	80	8
İS10	20-0065.0602	65	80	8,5
İS10	20-0065.1510	65	80	9
İS10	20-0065.1027	65	80	10
İS10	20-0065.0694	65	80	12
İS10	20-0065.0021	65	85	12
İS10	20-0065.1250	65	90	9,5
İS10	20-0065.0753	65	90	10
İS10	20-0066.1195	66	78	8
İS10	20-0066.0462	66,7	76,2	11,8
İS10	20-0067.0365	67	75	5,5
İS10	20-0067.0000	67	80	12
İS10	20-0067.0244	67	85	14
İS10	20-0068.1192	68	76	6
İS10	20-0068.1198	68	80	10
İS10	20-0068.0061	68	85	9
İS10	20-0068.0290	68	90	13
İS10	20-0068.0000	70	75	3,4
İS10	20-0068.0160	70	78	11
İS10	20-0070.0713	70	80	4,2
İS10	20-0070.0493	70	80	8
İS10	20-0070.0372	70	80	10
İS10	20-0070.0222	70	80	12
İS10	20-0070.0326	70	85	10

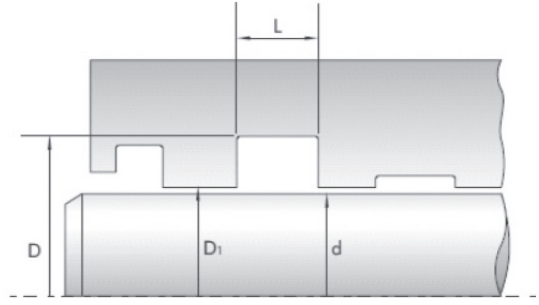
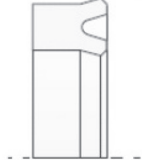

NUTRİNG KEÇE İS10				
TİP	REF. NO	ø d	ø D	B
İS10	20-0070.1333	70	85	12
İS10	20-0070.0873	70	86	8
İS10	20-0070.0064	70	90	10
İS10	20-0070.0022	70	90	12
İS10	20-0070.1226	70	92	15
İS10	20-0070.1176	70	95	16
İS10	20-0072.0306	72	80	12
İS10	20-0072.0366	72	82	5,5
İS10	20-0072.0630	72	82	7
İS10	20-0072.0314	72	83	7
İS10	20-0074.0742	74	86	10
İS10	20-0075.1365	75	85	6,5
İS10	20-0075.1332	75	85	7
İS10	20-0075.0775	75	85	8
İS10	20-0075.1410	75	85	10
İS10	20-0075.0052	75	88,5	6
İS10	20-0075.0871	75	90	7,5
İS10	20-0075.0009	75	90	10
İS10	20-0075.0643	75	95	10
İS10	20-0075.0023	75	95	12
İS10	20-0075.0134	75,5	89	7,5
İS10	20-0076.0421	76	87	10,7
İS10	20-0076.1225	76	92	10
İS10	20-0076.1166	76,2	88,9	9,92
İS10	20-0076.0000	79	85	5
İS10	20-0079.0035	79	101,5	11
İS10	20-0080.1387	80	90	4,8
İS10	20-0080.0879	80	90	12
İS10	20-0080.0155	80	100	6,5
İS10	20-0080.0024	80	100	12
İS10	20-0080.0000	80	101	12
İS10	20-0080.0000	80	101	15
İS10	20-0080.0923	80	102	10

NUTRİNG KEÇE İS10				
TİP	REF. NO	ø d	ø D	B
İS10	20-0080.0924	80	105	10
İS10	20-0082.0492	82	94	4,5
İS10	20-0082.1287	82,55	92,07	4,76
İS10	20-0084.0161	84	94	14
İS10	20-0084.0007	84	100	13
İS10	20-0084.1294	84,5	96	9,5
İS10	20-0085.0228	85	95	6
İS10	20-0085.1249	85	95	10
İS10	20-0085.0000	85	98	9
İS10	20-0085.0505	85	100	9
İS10	20-0085.0993	85	100	11,5
İS10	20-0085.0530	85	105	7,5
İS10	20-0085.0000	85	110	10
İS10	20-0085.1330	85	110	13
İS10	20-0085.0440	85,5	101,5	7
İS10	20-0085.0000	85,9	102,3	9,5
İS10	20-0086.0619	86,5	101,5	13,5
İS10	20-0087.0348	87	105	9,5
İS10	20-0088.0684	88	97	4,3
İS10	20-0088.1006	88	98	9
İS10	20-0088.0038	88	105	8
İS10	20-0088.1180	88	110	17
İS10	20-0088.0040	88,39	101,6	9,92
İS10	20-0088.1380	88,9	98,89	4,35
İS10	20-0088.0569	88,9	101,6	6,3
İS10	20-0088.0243	88,9	101,6	7
İS10	20-0088.0000	88,9	101,6	12,7
İS10	20-0089.0284	89	99	10
İS10	20-0089.0043	89	100	8
İS10	20-0089.0000	89	117	15
İS10	20-0090.0774	90	100	6
İS10	20-0090.0874	90	100	7
İS10	20-0090.0000	90	100	7,5

NUTRİNG KEÇE İS10				
TİP	REF. NO	ø d	ø D	B
İS10	20-0090.0364	90	100	8
İS10	20-0090.0017	90	100	10
İS10	20-0090.0360	90	100	12
İS10	20-0090.0422	90	101	10
İS10	20-0090.1367	90	102	6,5
İS10	20-0090.0538	90	102	7
İS10	20-0090.0119	90	102	10
İS10	20-0090.0000	90	105	9
İS10	20-0090.0019	90	110	8
İS10	20-0090.0644	90	110	10
İS10	20-0090.0025	90	110	12
İS10	20-0090.1011	90	113	5
İS10	20-0090.0000	90	114	8
İS10	20-0090.0758	90	115	10
İS10	20-0090.1227	90	115	12
İS10	20-0090.0620	90	116,5	21
İS10	20-0091.1296	91,5	102	8,5
İS10	20-0092.0531	92	100	4,2
İS10	20-0093.0912	93	110	9
İS10	20-0093.1297	93,5	102	8,5
İS10	20-0094.0731	94	122	17
İS10	20-0095.0878	95	105	8
İS10	20-0095.0037	95	107	9,5
İS10	20-0095.0997	95	110	10
İS10	20-0095.1528	95	115	10
İS10	20-0096.0054	96	111	8,5
İS10	20-0097.0357	97	105	8
İS10	20-0098.1394	98	108	8
İS10	20-0098.0549	98	112	9,5
İS10	20-0098.0545	98	117	9,5
İS10	20-0098.0000	98	118	11
İS10	20-0098.0000	95	115	10
İS10	20-0100.0375	100	110	10
İS10	20-0100.0036	100	110	14
İS10	20-0100.1384	100	110	16
İS10	20-0100.1393	100	112	12
İS10	20-0100.1636	100	113	10,3
İS10	20-0100.0000	100	115	10
İS10	20-0100.0815	100	120	10
İS10	20-0100.1395	100	120	12
İS10	20-0100.0324	100	120	15
İS10	20-0100.0026	100	125	15
İS10	20-0100.0812	100	130	10
İS10	20-0100.0000	101,6	114,3	7

NUTRİNG KEÇE İS10				
TİP	REF. NO	ø d	ø D	B
İS10	20-0104.0487	104	117	6,7
İS10	20-0104.1247	104	127	7
İS10	20-0105.0486	105	112	5
İS10	20-0105.0000	105	115	10,2
İS10	20-0105.0513	105	125	12
İS10	20-0105.0945	105	135	15
İS10	20-0105.0908	105	135	18
İS10	20-0106.0521	106	125	8
İS10	20-0107.0358	107	127	10
İS10	20-0108.0278	108	118	14
İS10	20-0100.1595	100	118	10
İS10	20-0110.1010	110	120	5
İS10	20-0110.0362	110	120	10
İS10	20-0110.1168	110	124	8,7
İS10	20-0110.0000	111	125	8
İS10	20-0110.1015	110	125	16
İS10	20-0110.0648	110	130	12
İS10	20-0110.0645	110	135	12
İS10	20-0110.0027	110	135	18
İS10	20-0110.0000	110	140	10
İS10	20-0111.1386	111	127	8,5
İS10	20-0111.0000	111	132,5	9
İS10	20-0111.0092	111,9	121	9,53
İS10	20-0112.0860	112	132	15
İS10	20-0113.0470	113	122	12
İS10	20-0113.0489	113	125	9
İS10	20-0113.0057	113	128	9
İS10	20-0113.0618	113	129	11,7
İS10	20-0114.1247	114	127	7
İS10	20-0115.0926	115	127	9
İS10	20-0115.0108	115	130	9
İS10	20-0115.0961	115	135	18
İS10	20-0115.0961	115	138	15
İS10	20-0115.0028	115	140	18
İS10	20-0115.0414	115	150	18
İS10	20-0115.0000	116	127	7
İS10	20-0117.0574	117	132	9,7
İS10	20-0117.0867	117	152	25
İS10	20-0120.1390	119	130	8
İS10	20-0120.0617	120	128	2,5
İS10	20-0120.0671	120	130	13,5
İS10	20-0120.1295	120	132	10
İS10	20-0120.0000	120	140	10
İS10	20-0120.0646	120	140	12

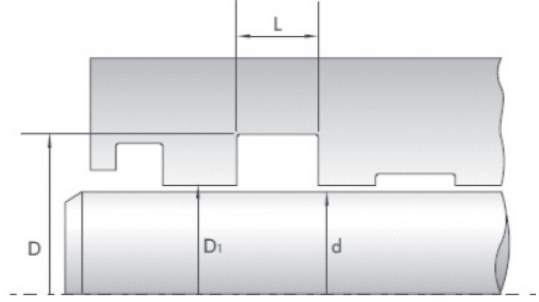
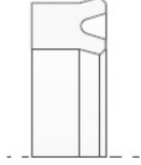
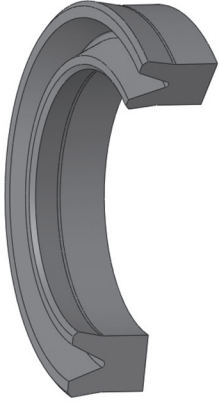

NUTRİNG KEÇE İS10				
TİP	REF. NO	$\varnothing d$	$\varnothing D$	B
İS10	20-0120.0960	120	140	18
İS10	20-0120.0922	120	145	8
İS10	20-0120.1368	120	145	15
İS10	20-0120.0029	120	145	18
İS10	20-0121.0403	121	137,5	14
İS10	20-0123.0880	123	135	10
İS10	20-0123.0848	123	137	9,5
İS10	20-0125.0279	125	135	13,5
İS10	20-0125.0868	125	140	9
İS10	20-0125.0969	125	140	18
İS10	20-0125.0183	125	145	15
İS10	20-0125.0967	125	145	18
İS10	20-0125.0000	125	155	15
İS10	20-0125.0030	125	155	18
İS10	20-0127.0177	127	139,7	9,52
İS10	20-0127.0097	127	152	16
İS10	20-0130.0717	130	144	7
İS10	20-0130.0512	130	145	14,5
İS10	20-0130.0759	130	150	10
İS10	20-0130.0679	130	152	19
İS10	20-0130.1167	130	152	11
İS10	20-0131.1271	131,76	147,62	11,5
İS10	20-0134.0398	134	150	10
İS10	20-0134.0120	134	153	16
İS10	20-0135.0124	135	145	2,5
İS10	20-0135.1515	135	150	9
İS10	20-0135.1292	135	150	10
İS10	20-0135.0089	135	160	12
İS10	20-0135.0622	135	160	15
İS10	20-0135.0347	135	160	18
İS10	20-0135.0483	135	165	5
İS10	20-0136.0831	136	150	8,5
İS10	20-0136.1017	136,5	152,4	7,9

NUTRİNG KEÇE İS10				
TİP	REF. NO	$\varnothing d$	$\varnothing D$	B
İS10	20-0137.0976	137	150	10
İS10	20-0137.0836	137,4	150,2	9,4
İS10	20-0138.0616	138,5	151	7,5
İS10	20-0139.0359	139,3	152,4	7
İS10	20-0140.1008	140	150	15
İS10	20-0140.1276	140	151	10
İS10	20-0140.0000	140	152	7,5
İS10	20-0140.1032	140	154	10
İS10	20-0140.0869	140	155	9
İS10	20-0140.0813	140	158	10
İS10	20-0140.0647	140	160	12
İS10	20-0140.0399	140	170	15
İS10	20-0140.0031	140	170	18
İS10	20-0142.0814	142	156	8
İS10	20-0142.0763	142	165	20
İS10	20-0143.1253	143	153	8
İS10	20-0145.1039	145	153	11,5
İS10	20-0145.0202	145	155	8
İS10	20-0145.0913	145	160	10
İS10	20-0145.0844	145	165	15
İS10	20-0145.1274	145	170	9,5
İS10	20-0147.0761	147	160	12
İS10	20-0147.1293	147	162	10
İS10	20-0148.0466	148	163	12
İS10	20-0149.0870	149	165	12
İS10	20-0150.0469	150	162	7,5
İS10	20-0150.1170	150	165	9
İS10	20-0150.0760	150	170	10
İS10	20-0150.0000	150	180	15
İS10	20-0150.0032	150	180	18
İS10	20-0150.0719	150	184	12
İS10	20-0150.0176	150	189	16
İS10	20-0153.0768	153	163	15

NUTRİNG KEÇE İS10				
TİP	REF. NO	ø d	ø D	B
İS10	20-0153.1229	153	180	15
İS10	20-0153.0977	153	183	15
İS10	20-0154.0822	154	161	6
İS10	20-0155.1273	155	169	18
İS10	20-0155.0780	155	175	10
İS10	20-0155.0000	155	185	19
İS10	20-0157.0578	157	185	20
İS10	20-0160.0716	160	174	7
İS10	20-0160.0941	160	175	9,5
İS10	20-0160.0031	160	180	8
İS10	20-0160.0650	160	180	12
İS10	20-0160.0718	160	180	15
İS10	20-0160.0685	160	184	19
İS10	20-0160.0033	160	190	22
İS10	20-0160.1275	160	177	6
İS10	20-0160.0000	163	177,8	7
İS10	20-0164.1230	164	184	13
İS10	20-0166.1291	166	200	20
İS10	20-0170.1200	170	181,5	6,5
İS10	20-0170.0767	170	185	12
İS10	20-0170.1376	170	200	15
İS10	20-0170.0034	170	200	22
İS10	20-0174.0400	174	182,7	8
İS10	20-0175.0727	175	183	7
İS10	20-0175.0583	175	209	10
İS10	20-0178.0651	178	200	11
İS10	20-0178.0845	178	210	16
İS10	20-0180.1289	180	200	9
İS10	20-0180.0185	180	200	14,5
İS10	20-0180.1473	180	200	15
İS10	20-0180.0762	180	205	20
İS10	20-0180.0238	180	210	17,5
İS10	20-0180.0035	180	210	22
İS10	20-0182.1329	182	200	22
İS10	20-0185.0730	185	195	8
İS10	20-0185.0162	185	200	12
İS10	20-0185.0098	185	205	20
İS10	20-0185.1383	185	210	15
İS10	20-0187.1280	187	202	6
İS10	20-0187.1030	187	203	8
İS10	20-0189.1016	189	209,5	12,5
İS10	20-0190.0805	190	220	15
İS10	20-0190.1042	190	220	18
İS10	20-0193.1199	193	201	4

NUTRİNG KEÇE İS10				
TİP	REF. NO	ø d	ø D	B
İS10	20-0193.0418	193	233	20
İS10	20-0196.1201	196,5	228,7	15,6
İS10	20-0200.0298	200	212	6,5
İS10	20-0200.0000	200	216	7,5
İS10	20-0200.0000	200	220	10
İS10	20-0200.0471	200	220	12
İS10	20-0200.0000	200	220	15
İS10	20-0200.0525	200	220	18
İS10	20-0200.0653	200	230	16
İS10	20-0200.0036	200	230	22
İS10	20-0200.0846	200	240	20
İS10	20-0200.0468	202	212	13
İS10	20-0203.0655	203	225	11
İS10	20-0203.0652	203	227	14
İS10	20-0203.0465	203	229	13,5
İS10	20-0204.0654	204	222	12
İS10	20-0204.1362	204,79	217,5	7,5
İS10	20-0205.0519	205	217	9,5
İS10	20-0205.1171	205	218	10
İS10	20-0209.1281	209	245	4,5
İS10	20-0210.1593	210	225	9,5
İS10	20-0210.0546	210	228	10
İS10	20-0210.1398	210	235	18
İS10	20-0210.0847	210	240	14
İS10	20-0212.1048	212	237	19
İS10	20-0212.0000	213	230	10
İS10	20-0214.0577	214	238	12
İS10	20-0214.1360	214,3	254,3	14,87
İS10	20-0215.1035	215	235	12
İS10	20-0215.0682	215	235	28
İS10	20-0215.0865	215	245	15
İS10	20-0215.1033	215	250	20
İS10	20-0216.1228	216	229	6,5
İS10	20-0220.0764	220	245	12
İS10	20-0220.1538	220	260	15
İS10	20-0220.0178	220	260	20
İS10	20-0226.0582	226	268	20
İS10	20-0235.0837	235	254	13
İS10	20-0235.0581	235	255	10,5
İS10	20-0235.0000	235,5	254	9
İS10	20-0236.0940	236	261	19
İS10	20-0238.1628	238	254	8
İS10	20-0240.1241	240	270	17
İS10	20-0240.0000	240	285	26

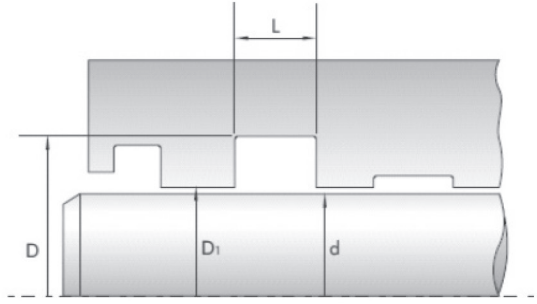
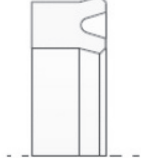
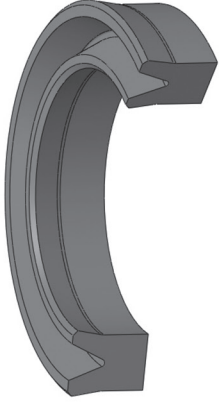

NUTRİNG KEÇE İS10				
TİP	REF. NO	$\emptyset d$	$\emptyset D$	B
İS10	20-0245.0315	245	257	6,5
İS10	20-0245.1170	245	265	12
İS10	20-0250.1240	250	280	18
İS10	20-0250.1202	250	280	25
İS10	20-0250.1421	250	290	20
İS10	20-0250.0864	250	300	30
İS10	20-0255.0939	255	280	19
İS10	20-0258.1592	258	266	7
İS10	20-0260.0685	260	278	14
İS10	20-0260.1034	260	280	10
İS10	20-0260.1286	260	300	20
İS10	20-0270.0825	270	300	18
İS10	20-0275.0838	275	302	18
İS10	20-0280.1633	280	300	15
İS10	20-0280.1416	280	320	20
İS10	20-0280.0862	280	350	25
İS10	20-0288.1285	288	320	22
İS10	20-0288.0000	290	320	15
İS10	20-0288.0000	295	320	10
İS10	20-0295.1169	295	320	11,3
İS10	23-0302.1206	302	338	17,5
İS10	20-0310.0683	310	355	30
İS10	20-0310.0535	310	355	37
İS10	20-0315.0467	315	345	20
İS10	20-0315.0344	315	345	25
İS10	20-0315.0229	315	350	20
İS10	20-0315.0000	320	336	8
İS10	20-0320.0523	320	350	15
İS10	20-0320.1423	322	355	11
İS10	20-0330.1245	330	360	25
İS10	20-0335.0819	335	355	18
İS10	20-0340.0935	340	370	15
İS10	20-0340.0000	340	380	19,5

NUTRİNG KEÇE İS10				
TİP	REF. NO	$\emptyset d$	$\emptyset D$	B
İS10	20-0345.1213	345	370	15
İS10	20-0345.1213	348	382	20
İS10	20-0355.0820	355	385	20
İS10	20-0360.0175	360	400	28
İS10	20-0370.1212	370	400	16
İS10	20-0381.1211	381	406,5	16
İS10	20-0380.1424	380	420	18
İS10	20-0388.1435	388	420	20
İS10	20-0388.1207	388	420	25
İS10	20-0390.0524	390	422	16
İS10	20-0400.0798	400	440	20
İS10	20-0400.0000	403	420	12
İS10	20-0405.1210	405	432	15
İS10	20-0410.1209	410	450	25
İS10	20-0415.0194	415	456	20
İS10	20-0425.1046	425	510	30
İS10	20-0430.1047	430	460	16
İS10	20-0433.1214	433	463	16
İS10	20-0433.0000	438,5	456,5	11,5
İS10	20-0450.0984	450	470	12
İS10	20-0450.1208	450	475	12
İS10	20-0450.1215	450	490	25
İS10	20-0450.0000	470	490	12
İS10	20-0485.1049	485	510	13
İS10	20-0500.1050	500	516	10
İS10	20-0500.1425	500	520	16
İS10	20-0500.0000	505	530	16
İS10	20-0550.1436	550	600	25
İS10	20-0580.1434	580	600	15
İS10	20-0600.0934	600	630	25
İS10	20-0600.0928	600	635	25
İS10	20-0600.0927	600	650	25
İS10	20-0640.1427	640	675	25

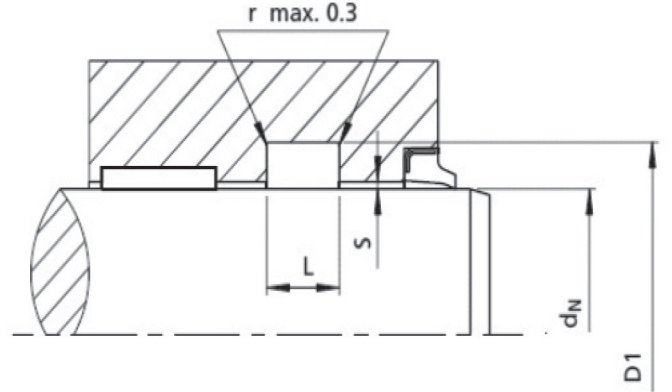
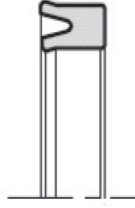

ROD NUTRİNG İS12				
TİP	REF. NO	ø d	ø D	B
İS12	22-0003.1372	3,7	7,3	3
İS12	22-0005.0260	5	12,5	8
İS12	22-0005.0192	5	15	10
İS12	22-0006.1242	6	12	4X3
İS12	22-0006.1001	6	12	4,2
İS12	22-0006.0441	6,5	12,5	4,3
İS12	22-0006.0795	6,5	12,5	9
İS12	22-0007.1266	7	12	2,5
İS12	22-0007.0794	7	12	8
İS12	22-0007.0626	7,5	12,5	4
İS12	22-0008.0008	8	16	5,5
İS12	22-0008.1326	8	16	5,7
İS12	22-0008.0330	8,5	13,5	4
İS12	22-0008.0296	8,5	14,5	4,5
İS12	22-0009.0368	9	14,5	4
İS12	22-0009.0318	9	15	4
İS12	22-0010.1580	10	16	3,7
İS12	22-0010.0079	10	16	4,5
İS12	22-0014.1251	10	16	6,2
İS12	22-0010.0010	10	18	5,5
İS12	22-0010.1353	10,82	17,7	3,5
İS12	22-0011.0297	11	16	4,3
İS12	22-0011.0427	11	17	4
İS12	22-0012.0012	12	20	5,5
İS12	22-0012.0053	12,8	19	3,5
İS12	22-0014.1314	14	21,8	4,3
İS12	22-0014.1288	14	21,8	4,8
İS12	22-0014.0968	14	22	5
İS12	22-0014.0948	14	22	5,5
İS12	23-0014.1183	14,4	22,4	4,5
İS12	22-0015.0027	15,5	22	4,5
İS12	22-0015.0147	15,5	22,5	10
İS12	22-0015.0000	15,9	22,2	4,7

ROD NUTRİNG İS12				
TİP	REF. NO	ø d	ø D	B
İS12	22-0016.1612	16	23	5
İS12	22-0016.0738	16	23	6,5
İS12	22-0016.0016	16	24	5,5
İS12	22-0017.0455	17	28	8
İS12	22-0017.0000	17,5	23,8	4,6
İS12	22-0018.1018	18	26	5
İS12	22-0018.0018	18	26	5,5
İS12	22-0019.0450	19	25	5,5
İS12	22-0019.0000	19	25,4	4,7
İS12	22-0019.1613	19	30	8
İS12	22-0019.0611	19,5	26,5	5
İS12	20-0019.0632	19,5	28	6
İS12	20-0020.1232	20	28	5,2
İS12	22-0020.0020	20	28	5,5
İS12	22-0020.0514	20	28	5,5
İS12	22-0020.0333	20,5	28,5	5,5
İS12	22-0020.0150	20,7	28,3	5
İS12	22-0021.0803	21	26	5,5
İS12	22-0021.0808	21	34	6,5
İS12	22-0021.0030	21,5	26,5	5
İS12	22-0022.0022	22	30	5,5
İS12	22-0022.1304	22	30	5,7
İS12	22-0022.0725	22	30	7
İS12	22-0022.1353	22,2	30,3	5,34
İS12	22-0022.0000	22,22	30,8	5,7
İS12	22-0024.0695	24	35	7
İS12	22-0024.0614	24,5	34	5,5
İS12	22-0025.0390	25	32	6
İS12	22-0025.0889	25	35	6
İS12	22-0025.1621	25	37	6,5
İS12	22-0025.-0025	25	35	7
İS12	22-0025.1632	25,4	38,1	6,3
İS12	22-0025.0769	25,5	32	5,5

ROD NUTRİNG İS12				
TİP	REF. NO	ø d	ø D	B
İS12	22-0025.0998	25,5	36	7
İS12	22-0026.0808	26	38	6,8
İS12	22-0027.1025	27	46	11
İS12	22-0027.0955	27,5	44	10,5
İS12	22-0028.0678	28	37	6
İS12	22-0028.0028	28	38	7
İS12	22-0030.1305	30	38	6
İS12	22-0030.0824	30	40	5
İS12	22-0030.0801	30	40	5,5
İS12	22-0030.0280	30	40	7
İS12	22-0030.0743	30	42	8,5
İS12	22-0030.0407	30	56	25
İS12	22-0031.0029	31	43	6,3
İS12	22-0032.0032	32	42	7
İS12	22-00320221	32	47	7
İS12	22-0032.0739	32	47	8
İS12	22-0035.1570	35	45	7
İS12	22-0033.0929	33	55	10,5
İS12	22-0036.0049	36	44	7,3
İS12	22-0036.0391	36	46	7
İS12	22-0036.0217	36	47	7
İS12	22-0036.0036	36	47	7
İS12	22-0038.0409	38	64	25
İS12	22-0038.1158	38,5	50	10
İS12	22-0040.0858	40	48	10,5
İS12	22-0040.0040	40	50	7
İS12	22-0040.0737	40	51	8,5
İS12	22-0041.0604	41,5	51,5	7
İS12	22-0042.0042	42	52	7
İS12	22-0042.0893	42	57,5	12
İS12	22-0045.0045	45	55	7
İS12	22-0045.0381	45	55,5	6
İS12	22-0045.1622	45	56	7,5
İS12	22-0048.0970	48	56	11,5
İS12	22-0048.0937	48	58	7
İS12	22-0048.0406	48	61,5	9,5
İS12	22-0048.1507	48	63	9,5
İS12	22-0048.0408	48	74	25
İS12	22-0050.0050	50	60	7
İS12	22-0050.0393	50	60	8
İS12	22-0050.0555	50,8	60	5,5
İS12	22-0051.0996	51	59	4,5
İS12	22-0052.0410	52,5	80	25
İS12	22-0053.1259	53	65	8,5

ROD NUTRİNG İS12				
TİP	REF. NO	ø d	ø D	B
İS12	22-0054.0458	54	60,25	5
İS12	22-0054.0112	54	62	12
İS12	22-0054.0735	54	64,5	5,8
İS12	22-0055.0055	55	65	7
İS12	22-0055.0320	55	65	8
İS12	22-0056.0056	56	66	7
İS12	22-0056.0947	56	66	7,25
İS12	22-0056.1323	56	66	8
İS12	22-0056.1160	56,5	67	7,2
İS12	22-0058.0909	58	68	8
İS12	22-0060.0060	60	72	8,5
İS12	22-0063.0063	63	75	8,5
İS12	22-0065.0745	65	77	7,5
İS12	22-0065.0744	65	77	8,5
İS12	22-0065.0411	65	90	25
İS12	22-0067.0378	67	78	6
İS12	22-0068.1009	68	78	5
İS12	22-0070.0220	70	82	6,5
İS12	22-0070.0355	70	82	7,5
İS12	22-0070.0070	70	82	8,5
İS12	22-0070.0771	70	82	9
İS12	22-0072.0383	72	86	8
İS12	00-0072.0000	75	90	8
İS12	22-0078.0374	78	86	13,5
İS12	22-0080.0080	80	92	8,5
İS12	22-0080.0000	80	92	13,5
İS12	22-0080.0412	80	110	25
İS12	22-0082.0598	82	93	4,8
İS12	22-0083.0828	83	90	14
İS12	2.200.841.520	84	93	6
İS12	22-0085.0629	85	96	8,5
İS12	22-0086.0395	86	96	13
İS12	22-0087.0499	87	98	9,5
İS12	22-0088.0693	88	100	10
İS12	22-0088.1272	88,9	101,6	7,93
İS12	22-0090.0090	90	102	8,5
İS12	22-0090.1029	90	102	14
İS12	22-0090.1327	90,5	117,5	17,5
İS12	22-0095.1277	95,5	135	27,5/29
İS12	22-0100.0100	100	115	10
İS12	22-0106.0866	106	123	9
İS12	22-0108.0804	108	122	10
İS12	22-0110.0110	110	130	14
İS12	22-0120.0877	120	133	8

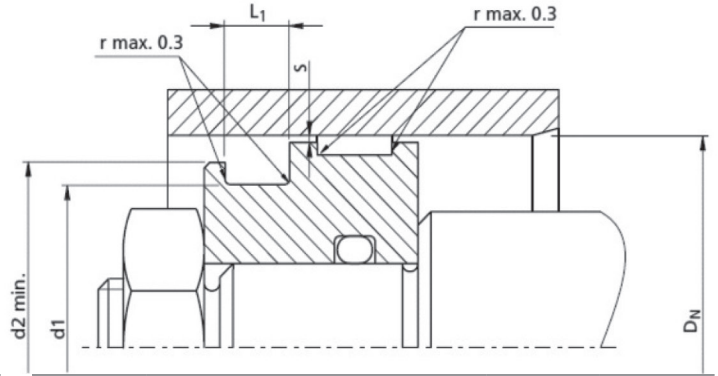
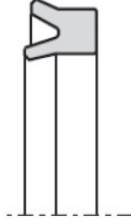
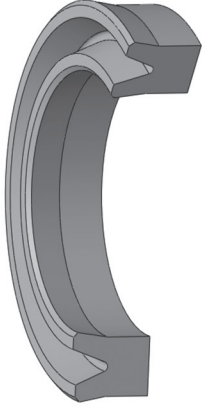

**PİSTON NUTRİNG
İS13**

TİP	REF. NO	$\varnothing D$	$\varnothing d$	B
İS13	23-0008.0015	8	3,5	2,7
İS13	23-0009.0128	9,5	6,2	2
İS13	23-0010.1343	10	7	2
İS13	23-0011.0802	11,5	6,5	3,5
İS13	23-0012.0012	12	6	4
İS13	23-0012.1258	12	7	2,5
İS13	23-0012.1459	12	9	5,5
İS13	23-0013.1001	13	6,5	3,8
İS13	23-0013.0141	13,3	9	3,5
İS13	23-0013.0000	13,5	10	2,2
İS13	23-0013.0088	13,7	8,7	3,4
İS13	23-0013.1317	13,8	6,3	4,3
İS13	23-0015.0121	15,5	11	3,5
İS13	23-0016.1336	16	10	2,5
İS13	23-0016.1338	16	10	3
İS13	23-0016.0016	16	10	4
İS13	23-0016.0075	16,5	10,5	2,6
İS13	23-0016.0975	16,5	11	4
İS13	23-0017.0069	17	12	3
İS13	23-0018.1339	18	12	3,5
İS13	23-0018.0510	18	13	3,5
İS13	23-0019.1599	19	12	4
İS13	23-0019.0792	19	14	6
İS13	23-00190062	19,5	12	5,6
İS13	23-0019.1536	19,5	12,7	4
İS13	23-0019.0026	19,5	13,5	6
İS13	23-0020.0020	20	12	5,5
İS13	23-0020.1625	20	15	6,5
İS13	23-0020.0129	20	16	3,5
İS13	23-0020.0074	20,2	12,2	2,5
İS13	23-0021.0190	21,7	16,3	4,8
İS13	23-0022.1476	22	12	6,5
İS13	23-0022.1581	22	14	6

**PİSTON NUTRİNG
İS13**

TİP	REF. NO	$\varnothing D$	$\varnothing d$	B
İS13	23-0022.0025	22	15	4,3
İS13	23-0022.1183	22,4	14,4	4X4,5
İS13	23-0023.0722	23	16	7
İS13	23-0023.0726	23,5	13,5	7
İS13	2.300.231.458	23,5	18	3,2
İS13	23-0024.0528	24	11	9
İS13	23-0024.0023	24	17	6,5
İS13	23-0025.1460	25	16,5	5,3
İS13	23-0025.0446	25	17	4,5
İS13	23-0025.0025	25	17	5,5
İS13	23-0025.1461	25	17	6,4
İS13	23-0025.0000	25	17	7
İS13	23-0025.0852	25	19	4,5
İS13	23-0025.0965	25	19	5
İS13	23-0025.0118	25,4	15,87	5,9
İS13	23-0025.0979	25,5	15,5	5,5
İS13	23-0025.1344	25,5	17,5	5
İS13	23-0026.1598	26	18	5
İS13	23-0026.1597	26	18	5,5
İS13	23-0026.1589	26	20	3,8
İS13	23-0027.1627	27	14	6,5
İS13	23-0027.0966	27	20	5
İS13	23-0028.0706	28	22	3,5
İS13	23-0030.1220	30	20	6
İS13	23-0030.1177	30	20	6,2
İS13	23-0030.0834	30	20	6,5
İS13	23-0030.1182	30	22	5
İS13	23-0030.0030	30	22	5,5
İS13	23-0030.0708	30	23	9
İS13	23-0030.1534	30	24	5,5
İS13	23-0030.0000	30	25,5	5,5
İS13	23-0030.0000	30,16	20,63	6,35
İS13	23-0030.0000	37,30	30,3	3,9

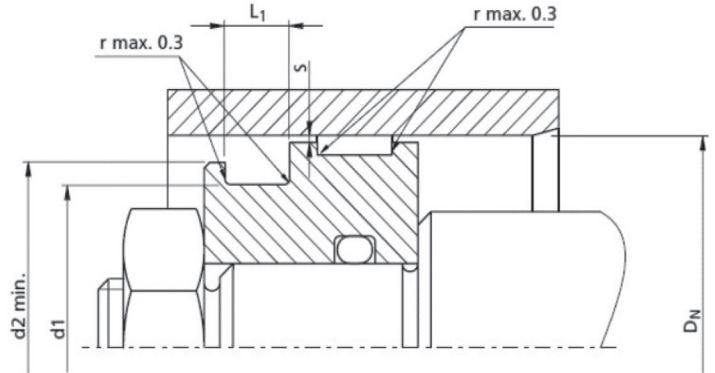
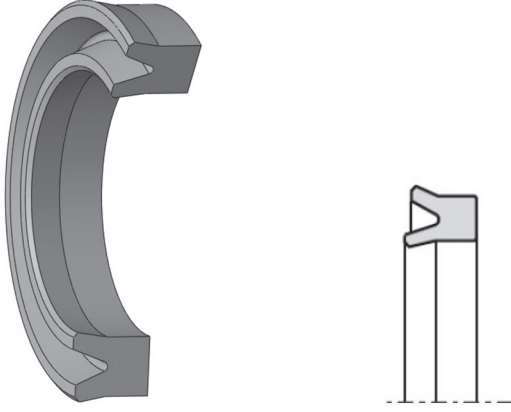

PİSTON NUTRİNG İS13				
TİP	REF. NO	ø D	ø d	B
İS13	23-0031.0042	31,2	26	5
İS13	23-0031.0103	31,5	24,5	5,2
İS13	23-0032.1036	32	22	8
İS13	23-0032.1223	32	24	5,5
İS13	23-0032.1159	32	25	4
İS13	23-0033.0337	33	15	9
İS13	23-0033.0507	33	27	4,5
İS13	23-0033.0526	33	27	5
İS13	23-0033.0439	33,5	21,5	5,5
İS13	23-0034.0016	34	23,5	10,5
İS13	23-0035.1480	35	27	5
İS13	23-0035.0035	35	27	5,5
İS13	23-0035.1306	35	28	6
İS13	23-0035.0000	36,5	25,4	6,35
İS13	23-0038.0978	38	28	8
İS13	23-0038.0796	38	30	6,5
İS13	23-0038.0000	38,7	25,9	6,3
İS13	23-0039.0554	39	32	8
İS13	23-0039.0613	39	32,5	8
İS13	23-0039.0322	39,5	32,5	3,5
İS13	23-0040.1349	40	28	7
İS13	23-0040.1178	40	30	6,5
İS13	23-0040.0415	40	30	7
İS13	23-0040.0048	40	30	7,7
İS13	23-0040.1336	40	32	3,25
İS13	23-0040.0584	40	32	7
İS13	23-0041.0269	41	33	7,5
İS13	23-0041.0791	41,5	31,5	7
İS13	23-0044.0434	44	26	9,8
İS13	23-0045.1505	45	32	3,3
İS13	2.300.451.498	45	33	4,5
İS13	23-0047.0099	47,6	38,5	7
İS13	23-0048.1366	48,9	38,2	7

PİSTON NUTRİNG İS13				
TİP	REF. NO	ø D	ø d	B
İS13	23-0049.0081	49	37,5	6
İS13	23-0050.0896	50	40	6
İS13	23-0050.0325	50	40	7
İS13	23-0050.1342	50	40	7,5
İS13	23-0050.1345	50,8	34,93	7,93
İS13	23-0051.0292	51,5	40	9
İS13	23-0052.1263	52	40	7
İS13	23-0056.0156	56	43	6,5
İS13	23-0058.0336	58	44	10
İS13	23-0058.1261	58,5	48,5	5,5
İS13	23-0060.1609	60	40	12
İS13	23-0060.0883	60	48	6,5
İS13	23-0060.1342	60	50	6,5
İS13	23-0060.0416	60	50	7
İS13	23-0060.1340	60,7	50,8	7
İS13	23-0061.0237	61	46,5	9,5
İS13	23-0062.0248	62	52	6
İS13	23-0063.1174	63	47,5	9,5
İS13	23-0063.1298	63	47	9
İS13	23-0063.0004	63	47	9,4
İS13	23-0063.0885	63	48	9,5
İS13	23-0063.0394	63	53	6,5
İS13	23-0063.0350	63	53	7
İS13	23-0063.1557	63	48	12
İS13	23-0063.1472	63	54	4,5
İS13	23-0065.1579	65	50	8
İS13	23-0065.1469	65	53	8
İS13	23-0065.0010	65	54	8
İS13	23-0065.1479	65	55	6
İS13	23-0066.0152	66	52	8,4
İS13	23-0066.0289	66	56	7
İS13	23-0069.0558	69	56	8
İS13	23-0069.0882	69	58	8

PİSTON NUTRİNG İS13				
TİP	REF. NO	ø D	ø d	B
İS13	23-0069.1335	69,85	53,9	7,93
İS13	23-0070-1530	70	58	7
İS13	23-0070.0070	70	60	7
İS13	23-0073.0741	73	55	12,5
İS13	23-0074.1619	74	66	6
İS13	23-0075.1482	75	60	8
İS13	23-0076.1634	76,2	57,1	12,7
İS13	23-0077.0818	77	62	10
İS13	23-0078.0082	78	63	8
İS13	23-0078.0000	79	60	9,5
İS13	23-0079.0946	79	63	8
İS13	23-0079.0560	79	63	12
İS13	23-0079.0000	79,38	66,63	6,35
İS13	23-0080.0000	80	60	10
İS13	23-0080.0396	80	64	8
İS13	23-0080.0460	80	65	7,8
İS13	23-0080.1556	80	67	6,5
İS13	23-0080.0550	80	68	8,5
İS13	23-0080.0990	80	68	9,5
İS13	23-0080.0920	80	70	7
İS13	23-0083.1454	83	72	9
İS13	23-0084.1270	84	72	9
İS13	23-0087.1347	87	70	10
İS13	23-0090.0219	90	78	8
İS13	23-0090.0456	90	78	8,5
İS13	23-0090.0963	90	78	9
İS13	23-0090.0139	90,5	75,5	7
İS13	23-0094.0041	94	84	13,5
İS13	23-0095.0642	95	75	7,5
İS13	23-0095.0005	95	82	9,5
İS13	23-0095.0872	95	84	9
İS13	23-0095.1529	95	85	14
İS13	23-0097.0786	97	82	10,5/8
İS13	23-0098.0876	98	86	9
İS13	23-0098.0697	99	87	9,5
İS13	2.301.001.508	100	86	8,5
İS13	23-0100.0875	100	88	8
İS13	23-0100.0100	100	88	8,5
İS13	23-0100.1331	100	90	4,25
İS13	23-0101.1185	101,6	82,55	14,28
İS13	23-0101.1511	101,6	88,9	9,5
İS13	23-0105.0859	105	69	17,8
İS13	23-0108.1184	108	90	9 (özel)
İS13	23-0108.1248	108	94	9,5

PİSTON NUTRİNG İS13				
TİP	REF. NO	ø D	ø d	B
İS13	23-01110.0986	110	90	8
İS13	23-0110.1037	110	90	10
İS13	23-0110.0110	110	98	8,5
İS13	23-0110.0925	120	104	19
İS13	23-0124.1041	124	109	10
İS13	23-0125.1573	125	110	10
İS13	23-0131.1637	131	123	7
İS13	23-0135.1483	135	120	7
İS13	23-0139.0988	139	127	13
İS13	23-0139.1517	139,7	127	8
İS13	23-0140.0140	140	120	10
İS13	23-0140.1494	140	124	17,5
İS13	23-0141.1328	141	117,5	17
İS13	23-0146.1499	146	135	9,5
İS13	23-0150.1179	150	135	10
İS13	23-0152.1524	152,4	140	7
İS13	23-0154.1465	154	146	4
İS13	23-0155.0835	155	132	16
İS13	23-0160.0160	160	140	14
İS13	23-0160.0404	160	145	8
İS13	23-0160.0000	160	148	7
İS13	23-0165.1516	165	152,4	8
İS13	23-0167.1471	167	159,6	4
İS13	23-0172.1514	172	148	16
İS13	23-0177.1513	177,8	152,4	15,88
İS13	23-0180.0000	180	160	10
İS13	23-0180.1484	180	160	14
İS13	23-0182.1464	182	176	4
İS13	23-0184.1203	184	175	6
İS13	23-0197.0806	197	165	20
İS13	23-0200.1278	200	170	17
İS13	23-0200.1629	200	180	14
İS13	23-0200.1629	200	180	17
İS13	23-0200.1594	200	182	13,5
İS13	2.302.001.501	200	193	19
İS13	23-0215.1463	215	205,4	5,5
İS13	23-0215.1502	215	208	4
İS13	23-0218.1279	218	170	53
İS13	23-0220.0220	220	200	14
İS13	23-0240.1503	240	218	10
İS13	23-0250.1359	250	224	18
İS13	23-0250.0250	250	230	14
İS13	23-0266.1591	266	250	19
İS13	23-0280.0280	280	260	14

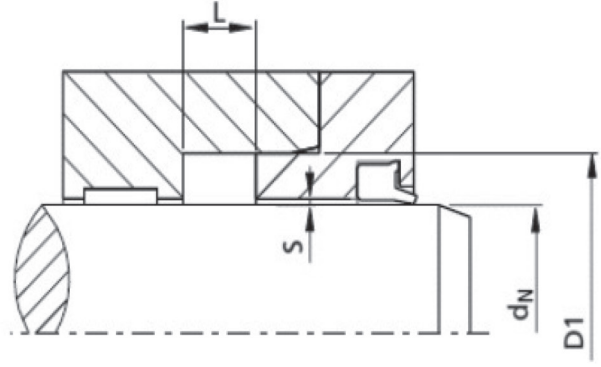
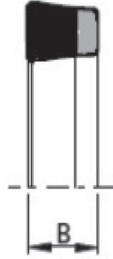
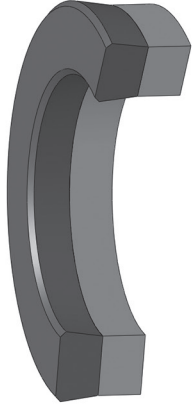

KOMPAKT KEÇE İS30				
TİP	REF. NO	$\varnothing d$	$\varnothing D$	B
İS30	16-0014.0007	14	22	6
İS30	16-0015.0015	15	24	6,5
İS30	16-0016.0037	16	24	7,5
İS30	16-0016.0011	16	24,5	6,4
İS30	15-0020.0001	20	28	6
İS30	15-0022.0002	22	30	6
İS30	15-0025.0003	25	33	6
İS30	16-0025.0036	25,4	38,1	8,8
İS30	16-0027.0012	27	35	6
İS30	15-0028.0004	28	36	6
İS30	15-0030.0005	30	38	6
İS30	16-0030.0005	30	40	10
İS30	16-0031.0013	31,5	39	6
İS30	15-0032.0006	32	40	6
İS30	15-0035.0007	35	43	6
İS30	16-0035.0035	35	44	7
İS30	15-0036.0008	36	44	6
İS30	16-0036.0003	36	46	8
İS30	16-0038.0004	38	45	7
İS30	16-0038.0010	38	46	4
İS30	16-0038.0008	38	48	9,5
İS30	15-0040.0009	40	48	6
İS30	15-0042.0010	42	50	6
İS30	16-0045.0033	45	54,5	6,5
İS30	15-0045.0011	45	55	7,5
İS30	15-0050.0012	50	60	7,5
İS30	16-0054.0002	54	65	8
İS30	15-0055.0013	55	65	7,5
İS30	15-0056.0014	56	66	7,5
İS30	16-0060.0032	60	69,5	6,5
İS30	15-0060.0015	60	70	7,5
İS30	16-0060.0006	60	72	9,5
İS30	15-0063.0016	63	75	9

KOMPAKT KEÇE İS30				
TİP	REF. NO	$\varnothing d$	$\varnothing D$	B
İS30	15-0065.0017	65	77	9
İS30	15-0070.0018	70	82	9
İS30	16-0070.0009	70	83	9,5
İS30	15-0075.0019	75	87	9
İS30	16-0076.0031	76	85,5	6,5
İS30	15-0080.0020	80	92	9
İS30	16-0080.0016	80	95	20
İS30	15-0085.0021	85	97	9
İS30	15-0090.0022	90	102	9
İS30	16-0092.0030	92	101,5	6,5
İS30	16-0095.0038	95	107	14
İS30	15-0100.0023	100	115	11,2
İS30	16-0107.0029	107	117,5	6,5
İS30	15-0110.0024	110	125	11,2
İS30	16-0115.0034	115	145	19
İS30	15-0115.0025	115	130	11,2
İS30	16-0116.0026	116	124	8
İS30	16-0120.0018	120	132	7
İS30	15-0120.0026	120	135	11,2
İS30	16-0120.0028	120	135,5	6,5
İS30	15-0125.0027	125	140	11,2
İS30	16-0125.0017	125	150	14
İS30	16-0135.0027	135	143	8
İS30	16-0135.0039	135	147	14
İS30	15-0140.0028	140	160	15
İS30	16-0140.0020	140	152	7
İS30	16-0145.0001	145	157	8,5
İS30	15-0150.0029	150	170	15
İS30	16-0154.0024	154	162	7
İS30	16-0154.0019	154	162	8
İS30	16-0158.0023	158	170	7
İS30	15-0160.0030	160	180	15
İS30	16-0175.0040	175	187	14

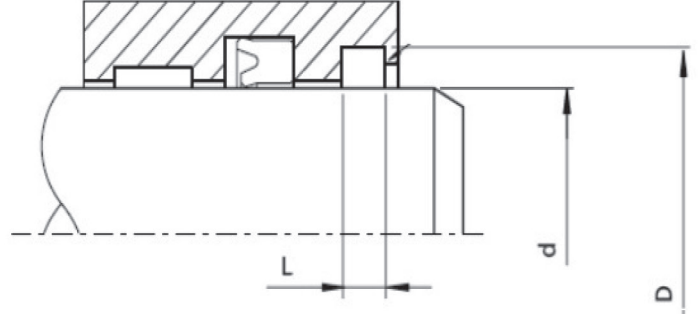
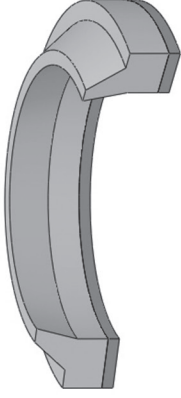

TOZ KEÇESİ İS93				
TİP	REF. NO	ø d	ø D	B
İS93	36-0006.0047	6	11	3/4,5
İS93	36-0008.0085	8	16	3/6,5
İS93	36-0010.0088	10	16	1/3
İS93	36-0010.0030	10	16	2,3/3,5/5
İS93	36-0011.0089	11	21	2/7
İS93	36-0012.0062	12,5	18	3,5/5
İS93	36-0012.0092	12,5	20	3/6,5
İS93	36-0012.0010	12,8	19,4	2,5/4,5
İS93	36-0013.0133	13	24	4/7
İS93	36-0014.0182	14	20	3,5/5,5
İS93	36-0014.0029	14,5	22,5	4,8/6
İS93	36-0015.0024	15	23	5/7
İS93	36-0016.0097	16	20	1/5
İS93	36-0016.0171	16	22	2,5/4,5
İS93	36-0016.0014	16	23	5,3/8,3
İS93	36-0016.0213	16	24	5/2
İS93	36-0016.0086	16	25	3/6,5
İS93	36-0016.0098	16,5	24	5/8
İS93	36-0017.0036	17	24	5/7
İS93	36-0017.0073	17	25	5
İS93	36-0017.0056	17	26	5/7,5
İS93	36-0017.0022	17	27	3,5/5,5
İS93	36-0018.0080	18	24,5	3/5,5
İS93	36-0018.0031	18	26	5/7
İS93	36-0018.0087	18	28	3/6,5
İS93	36-0019.0169	19	26	3,5/6
İS93	36-0020.0046	20	28	2/8
İS93	35-0020.0001	20	28	5/7
İS93	36-0020.0102	20	28	7/10
İS93	36-0020.0021	20	29,2	2,7/6
İS93	36-0020.0013	20	30	5/9
İS93	36-0020.0005	20	34	3/8
İS93	36-0021.0049	21	35	2/7

TOZ KEÇESİ İS93				
TİP	REF. NO	ø d	ø D	B
İS93	36-0022.0168	22	28	3/4
İS93	36-0022.0099	22	29,5	7,4
İS93	35-0022.0002	22	30	5/7
İS93	36-0022.0083	22	32	4/6
İS93	36-0022.0033	22	32	5/7
İS93	360022.-0054	22	34	6/9
İS93	36-0023.0048	23	30	5,5/8
İS93	36-0023.0129	23	32	5/6,7
İS93	36-0023.0167	23,5	30,5	5/7
İS93	36-0024.0006	24,5	35,5	2/7,5
İS93	36-0025.0001	25	32,5	1,8/5
İS93	35-0025.0003	25	33	5/7
İS93	36-0025.0007	25	34	5/7
İS93	36-0025.0034	25	37	5/7
İS93	36-0025.0012	25,5	34,5	6,5/10
İS93	36-0026.0101	26	34	2/4,5
İS93	36-0026.0186	26	34,4	5/7
İS93	36-0026.0038	26	36	5/7
İS93	36-0028.0077	28	33	4,5/7,5
İS93	35-0028.0004	28	36	5/7
İS93	35-0030.0005	30	38	5/7
İS93	35-0030.0206	30	45	5/8
İS93	36-0032.0131	32	40	3,5/5
İS93	36-0032.0166	32	40	4,2/5,5
İS93	35-0032.0006	32	40	5/7
İS93	36-0033.0032	33	56	4/12,5
İS93	35-0035.0007	35	43	5/7
İS93	36-0035.0050	35	48	3/8
İS93	36-0036.0180	36	44	4/5/7
İS93	35-0036.0008	36	44	5/7
İS93	36-0036.0185	36	46	2,5/5
İS93	36-0037.0160	37	43	5/7
İS93	36-0038.0153	38	50	7/9

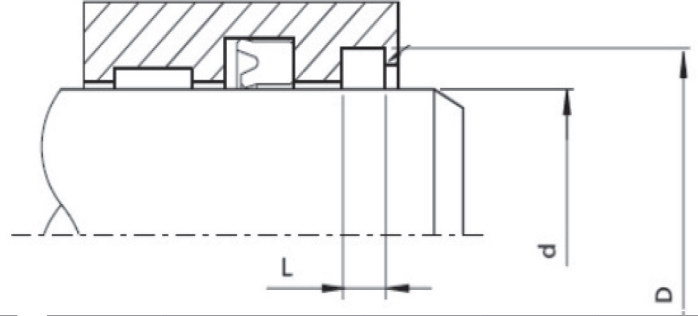
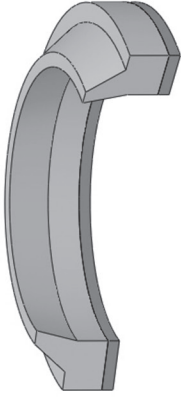

TOZ KEÇESİ İS93				
TİP	REF. NO	ø d	ø D	B
İS93	36-0038.0081	38,3	49,3	5/7
İS93	36-0039.0212	39	48	5/7
İS93	36-0040.0075	40	47	5/7
İS93	36-0040.0183	40	48	4/5/7
İS93	35-0040.0009	40	48	5/7
İS93	36-0040.0053	40	50	5/7
İS93	36-0040.0130	40	52	5/10
İS93	36-0040.0044	40,5	49,5	6,5/8
İS93	36-0042.0128	42	48	2,5/4
İS93	35-0042.0010	42	50	5/7
İS93	36-0045.0076	45	52	4,5/7
İS93	36-0045.0170	45	53	5/7
İS93	36-0045.0090	45	54	5/7
İS93	35-0045.0011	45	55	5/7
İS93	36-0046.0063	46	54	5/7
İS93	36-0050.0177	50	58	4/5/7
İS93	36-0050.0055	50	58	5/7
İS93	36-0050.0181	50	58	5,5/7
İS93	35-0050.0012	50	60	5/7
İS93	36-0050.0096	50	63	8/12
İS93	36-0050.0060	50	65	7,5/10
İS93	36-0050.0066	50,5	63	5/7
İS93	35-0055.0013	55	65	5/7
İS93	36-0055.0091	55	75	3/9
İS93	36-0056.0132	56	64	4/5/7
İS93	35-0056.0014	56	66	5/7
İS93	36-0057.0100	57	61	2/4
İS93	36-0058.0078	58	65	3/5
İS93	35-0060.0015	60	70	5/7
İS93	36-0060.0179	60	72	8/12
İS93	36-0061.0159	61	66	3/6,5
İS93	35-0063.0016	63	73	5/7
İS93	36-0063.0152	63,5	76,5	7/9

TOZ KEÇESİ İS93				
TİP	REF. NO	ø d	ø D	B
İS93	36-0064.0158	64	72,5	6,5/10
İS93	36-0065.0067	65	71	5/7
İS93	35-0065.0017	65	75	5/7
İS93	36-0066.0057	66	75	5,5/7,5
İS93	35-0070.0018	70	80	5/7
İS93	36-0070.0178	70	80	5,5/7,5
İS93	36-0070.0208	70	80	8/6
İS93	36-0070.0051	70	81	7/12
İS93	36-0070.0011	70	81,5	4,5/10
İS93	36-0070.0190	70	84	6/11
İS93	35-0075.0019	75	87	7/12
İS93	36-0076.0065	76	84	5/7
İS93	36-0076.0065	76	88	5/7,5
İS93	36-00780082	78	88	7/10
İS93	36-0078.0004	78	89	5,5/8
İS93	36-0080.0191	80	88,5	5/7
İS93	36-0080.0189	80	90	5/8
İS93	36-0080.0209	80	90	6,5/8
İS93	36-0080.0134	80	90	7/10
İS93	35-0080.0207	80	90	8/6
İS93	35-0080.0020	80	92	7/12
İS93	36-0085.0157	85	95	5/8
İS93	36-0085.0188	85	95	6,5/12,5
İS93	35-0085.0021	85	97	7/12
İS93	35-0090.0022	90	102	7/12
İS93	36-0095.0041	95	103	3/5
İS93	36-0095.0172	95	105	3/7
İS93	36-0100.0192	100	110	5/8
İS93	36-0100.0052	100	110	5/7/10
İS93	35-0100.0023	100	112	7/12
İS93	36-0105.0151	105	115	7/10
İS93	36-0105.0037	105	117	7/12
İS93	36-0106.0025	106	122	7/12

TOZ KEÇESİ İS93				
TİP	REF. NO			
		ø d	ø D	B
İS93	36-0107.0059	107	122	7/12,5
İS93	35-0110.0024	110	122	7/12
İS93	36-0114.0064	114	122	5/7
İS93	35-0115.0025	115	127	7/12
İS93	36-0120.0210	120	130	8/6
İS93	36-0120.0084	120,5	130	5,7/9,6
İS93	36-0120.0193	120	132	7/12
İS93	36-0125.0008	125	137	7/10
İS93	35-0125.0026	125	140	16/10
İS93	36-0130.0211	130	140	9,5/7
İS93	36-0135.0042	135	147	3,5/5
İS93	36-0135.0045	135	150	9/12
İS93	36-0135.0009	135	151	9/12
İS93	36-0136.0074	136	146,5	5/7
İS93	36-0140.0150	140	152	8/12
İS93	36-0140.0155	140	155	5/12
İS93	35-0140.0027	140	155	10/16
İS93	36-0145.0173	145	160	12/17
İS93	35-0150.0028	150	165	10/16
İS93	36-0160.0154	160	173	7/12
İS93	36-0160.0156	160	173	8,5/12,5
İS93	36-0160.0194	160	174	8,5/12
İS93	35-0160.0029	160	175	10/16
İS93	36-0165.0093	165	173	5/14
İS93	36-0165.0184	165	180	7/10
İS93	35-0170.0030	170	185	16/10
İS93	36-0170.0043	175	187	4/6
İS93	36-0180.0149	180	192	9/13
İS93	35-0180.0031	180	200	10/18
İS93	36-0190.0039	190	215	12/20
İS93	36-0200.0061	200	210	5/7/10
İS93	35-0200.0032	200	220	10/18
İS93	36-0210.0195	210	230	13/18
İS93	36-0215.0092	215	235	10/18
İS93	36-0245.0095	245	270	10/18
İS93	36-0260.0028	260	280	10/18
İS93	36-0260.0176	260	283	9,5/19
İS93	36-0330.0164	330	354	15/8
İS93	36-0337.0175	337	360	8/16
İS93	36-0360.0161	360	380	18/10
İS93	36-0400.0162	400	420	18/10
İS93	36-0420.0163	420	435	13/9,5/6,5

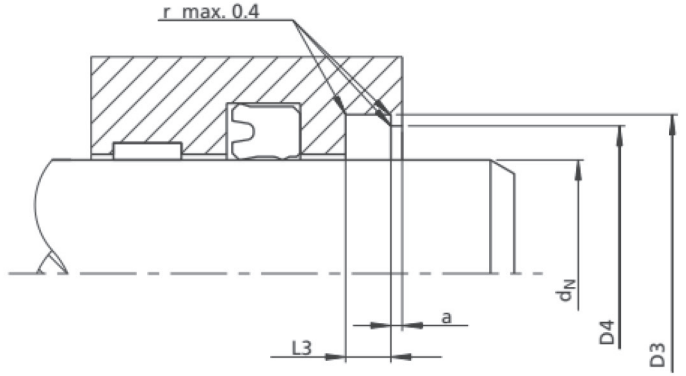
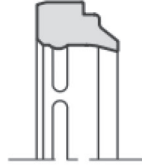

**KADEMELİ TOZ KEÇESİ
İS36**

TİP	REF. NO	$\varnothing d$	$\varnothing D$	B
İS36	34-0020.0001	20	28	4/7
İS36	34-0022.0002	22	30	4/7
İS36	34-0025.0003	25	33	4/7
İS36	34-0028.0004	28	36	4/7
İS36	34-0030.0005	30	38	4/7
İS36	34-0032.0006	32	40	4/7
İS36	34-0035.0007	35	43	4/7
İS36	34-0036.0008	36	44	4/7
İS36	34-0040.0009	40	48	4/7
İS36	34-0042.0010	42	50	4/7
İS36	34-0045.0011	45	53	4/7
İS36	34-0050.0012	50	58	4/7
İS36	34-0055.0013	55	63	4/7
İS36	34-0056.0014	56	64	4/7
İS36	34-0060.0015	60	68	4/7
İS36	34-0063.0016	63	71	4/7
İS36	34-0065.0017	65	73	4/7
İS36	34-0070.0018	70	78	4/7
İS36	34-0075.0019	75	83	4/7
İS36	34-0080.0020	80	88	4/7
İS36	34-0085.0021	85	93	4/7
İS36	34-0090.0022	90	98	4/7
İS36	34-0095.0023	95	103	4/7
İS36	34-0100.0024	100	108	4/7
İS36	34-0110.0025	110	122	5,5/10
İS36	34-0120.0026	120	132	5,5/10
İS36	34-0125.0027	125	137	5,5/10
İS36	34-0140.0028	140	152	5,5/10
İS36	34-0150.0029	150	162	5,5/10
İS36	34-0160.0030	160	172	5,5/10
İS36	34-0180.0031	180	192	5,5/10
İS36	34-0200.0032	200	212	5,5/10

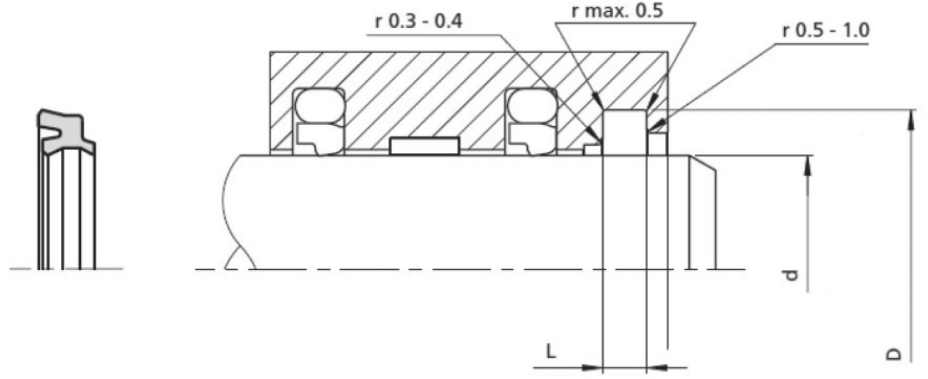

NUTRİNG DUDAKLI TOZ KEÇESİ İS18				
TİP	REF. NO	$\varnothing d$	$\varnothing D$	B
İS18	25-.0004.0076	4	7,5	3/3,5/4
İS18	25-0004.0075	4	7,5	3/4
İS18	25-0006.0058	6	11	3,5/5
İS18	25-0006.0124	6	11	4/5
İS18	25-0008.0061	8	12	3,5/5
İS18	25-0008.0098	8	13	4/5
İS18	25-0008.0060	8	14,5	5,5/3
İS18	25-0009.0037	9	14	3,4/5
İS18	25-0009.0000	9,5	16,5	4,2/5,7
İS18	25-0009.0107	9,7	13,5	3,5/4,5
İS18	25-0010.0002	10	14	3,8/5,8
İS18	25-0010.0093	10	14,4	3/4
İS18	25-0010.0063	10	16	3/6,3
İS18	25-0010.0094	10	16	4/4,5
İS18	25-0010.0016	10	16	4/5
İS18	25-0010.0018	10	16	4,5/5,5/6,5
İS18	25-0010.0056	10	18	5/8
İS18	25-0010.0090	10	18	5,5/8
İS18	25-0010.0011	10	20	7/9,5
İS18	25-0010.0006	10	22	4/5
İS18	25-0010.0064	10	24	4/6,5
İS18	25-0012.0103	12	16	4,5/3,5
İS18	25-0012.0003	12	17	4/5,5
İS18	25-0012.0049	12	19	3/5
İS18	25-0012.0108	12	19	3,5/4
İS18	25-0012.0089	12	19	3,5/4,8
İS18	25-0012.0066	12	20	6/8
İS18	25-0012.0042	12	22	5/6,5
İS18	25-0013.0050	13	18	4,5/7
İS18	25-0013.0123	13	20	5,5/7
İS18	25-0013.0027	13	23	5/6,5
İS18	25-0014.0019	14	20	4,5/6
İS18	25-0014.0022	14	24	5/7

NUTRİNG DUDAKLI TOZ KEÇESİ İS18				
TİP	REF. NO	$\varnothing d$	$\varnothing D$	B
İS18	25-0014.0017	14,5	20,5	4,5/6
İS18	25-0015.0096	15	23	4/7
İS18	25-0016.0116	16	20	5/6,5
İS18	25-0016.0067	16	22	5/7,5
İS18	25-0016.0114	16	23	4/5,5/7
İS18	25-0016.0005	16	24	5,5/6,5
İS18	25-0016.0028	16	25	5/6,3
İS18	25-0016.0033	16	26	4,8/6,7
İS18	25-0017.0092	17	23	3,5/5
İS18	25-0017.0008	17	24	5/6,5
İS18	25-0018.0048	18	26	4,5/6,5
İS18	25-0018.0010	18	28	5/6,5
İS18	25-0019.0111	19	29,5	7,8/9,8
İS18	25-0020.0106	20	26	3,5/5
İS18	25-0020.0101	20	26	4,5/3,5
İS18	25-0020.0095	20	28	4/6/8
İS18	25-0020.0045	20	28	5,5/7,5
İS18	25-0020.0044	20	30	5/9
İS18	25-0020.0059	20	30	6,5/7/9
İS18	25-0022.0115	22	28	3,5/5
İS18	25-0022.0121	22	30	4,6/6,2
İS18	25-0022.0122	22	30	5/6,5
İS18	25-0022.0109	22	30	5/7
İS18	25-0022.0026	22	30	6/7,5
İS18	25-0022.0021	22	32	6/7,5
İS18	25-0024.0053	24	37	7/10
İS18	25-0025.0024	25	33	5/6,5
İS18	25-0025.0007	25	33,5	5/6,5
İS18	25-0025.0052	25	35	5/6,5
İS18	25-0025.0051	25	35	7/8
İS18	25-0025.0054	25	35	7/9
İS18	25-0025.0014	25,5	34,5	7/9,5
İS18	25-0025.0015	25,5	36,5	10,5

NUTRİNG DUDAKLI TOZ KEÇESİ İS18				
TİP	REF. NO	ø d	ø D	B
İS18	25-0028.0118	28	36,7	4/6/8
İS18	25-0038.0035	30	38	4/6/8,5
İS18	25-0030.0142	30	39	8/6
İS18	25-0030.0034	30,8	38,1	7/9,5
İS18	25-0031.0009	31	39	5/7
İS18	25-0031.0119	31,5	39,8	5/7
İS18	25-0031.0029	32	42	5/6,5/9
İS18	25-0032.0072	32	46	5/6,5
İS18	25-0035.0073	35	43	5/7
İS18	25-0035.0023	35	44	4,6/8,5/6,5
İS18	25-0035.0004	35	44,5	5,5/7
İS18	25-0035.0091	35	45	5/7
İS18	25-0036.0020	36	44	5/6,7
İS18	25-0036.0110	36	49	3,7/5
İS18	25-0038.0067	38	46	6,5/9
İS18	25-0040.0013	40	48	4/6/8
İS18	25-0040.0102	40	48	11/16
İS18	25-0040.0068	40	50	5/7,5
İS18	25-0044.0057	44	53	5/6
İS18	25-0045.0105	45	58	11/16
İS18	25-0046.0047	46	54	7/5
İS18	25-0047.0000	47	58	4,3/6,8
İS18	25-0048.0125	48	56	6/7
İS18	25-0048.0083	48	60	6/9
İS18	25-0050.0012	50	58	5/7
İS18	25-0050.0000	50	58	6,5/7,5
İS18	25-0050.0041	50	60	6/8
İS18	25-0050.0141	50	62	10,5/8
İS18	25-0050.0100	50	60	6/9
İS18	25-0050.0104	50	62	4,5/7
İS18	25-0050.0036	50,8	59,4	5/6,3
İS18	25-0051.0030	51	59	5/6,5
İS18	25-0055.0062	55	65	5/7,5
İS18	25-0060.0084	60	68	3,6/5,5/6,8
İS18	25-0060.0001	60	80	10/18
İS18	25-0063.0043	63	71	4/5/7
İS18	25-0063.0025	63	75	7/9
İS18	25-0064.0032	64	76	6,8/8,8
İS18	25-0065.0038	65	72	4/5,5/8
İS18	25-0070.0099	70	75	5/7
İS18	25-0070.0085	70	78	3,6/5,5/6,8
İS18	25-0070.0140	70	80	10/12
İS18	25-0075.0117	75	87	7/12
İS18	25-0076.0031	76	88	6,8/8,8

NUTRİNG DUDAKLI TOZ KEÇESİ İS18				
TİP	REF. NO	ø d	ø D	B
İS18	25-0080.0086	80	88	3,6/5,5/6,8
İS18	25-0080.0088	80	90	6/8
İS18	25-0082.0039	82	92	6/7,5
İS18	25-0088.0055	88,9	101,6	6,7/8,7
İS18	25-0088.0120	88,9	101,6	9/12
İS18	25-0090.0087	90	98	3,6/5,5/6,8
İS18	25-0100.0000	100	108	4/6/8
İS18	25-0100.0040	100	112	7/9
İS18	25-0105.0139	105	115	8/6
İS18	25-0105.0000	105	117	5
İS18	25-0105.0000	105	117	8
İS18	25-0105.0000	105	117	11
İS18	25-0110.0000	110	122	8
İS18	25-0110.0000	110	122	11
İS18	25-0120.0000	120	132	8/11
İS18	25-0150.0138	150	163	9,5/7
İS18	25-0160.0046	160	180	10/16
İS18	25-0180.0065	180	196	9,5/12

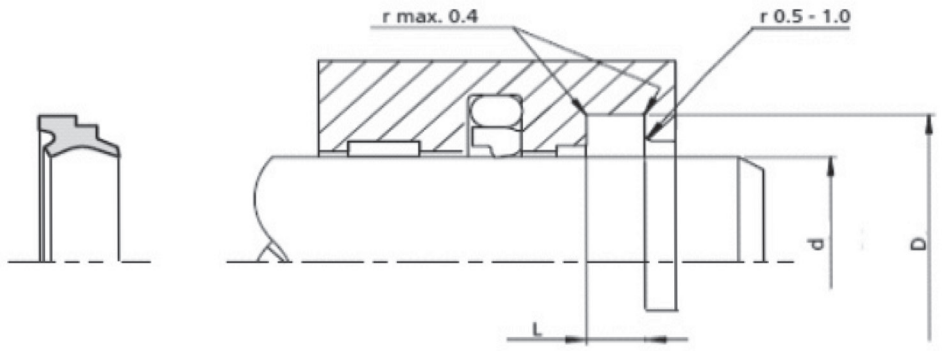

NUTRİNG DUDAKLI TOZ KEÇESİ
İS21

TİP	REF. NO	$\varnothing d$	$\varnothing D$	B
İS21	26-0020.0001	20	28	8/6
İS21	26-0025.0002	25	33	8/6
İS21	26-0030.0003	30	38	8/6
İS21	26-0032.0004	32	40	8/6
İS21	26-0036.0005	36	44	8/6
İS21	26-0040.0006	40	48	8/6
İS21	26-0050.0007	50	58	8/6
İS21	26-0055.0008	55	63	8/6
İS21	26-0060.0009	60	68	8/6
İS21	26-0065.0010	65	73	8/6
İS21	26-0070.0011	70	78	8/6
İS21	26-0075.0012	75	83	8/6
İS21	26-0080.0013	80	88	8/6
İS21	26-0090.0014	90	98	8/6
İS21	26-0100.0015	100	108	8/6
İS21	26-0110.0016	110	122	11/8,2
İS21	26-0120.0017	120	132	11/8,2
İS21	26-0125.0018	125	137	11/8,2
İS21	26-0130.0019	130	142	11/8,2
İS21	26-0140.0020	140	152	11/8,2
İS21	26-0150.0021	150	162	11/8,2
İS21	26-0160.0022	160	172	11/8,2
İS21	26-0180.0023	180	192	11/8,2
İS21	26-0200.0024	200	212	11/8,2

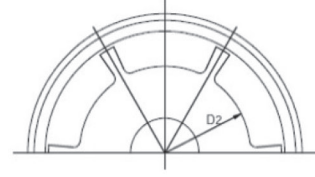
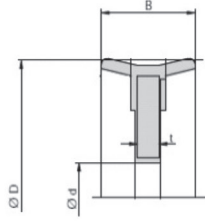

**PNÖMATİK PİSTON KEÇESİ
İS55**

TİP	REF. NO			
		Ø D	Ø d	B
İS55	30-0020.0001	20	5,2	8
İS55	30-0025.0002	25	8	12
İS55	30-0026.0003	26	8	12
İS55	30-0032.0004	32	8	15
İS55	30-0035.0005	35	8	15
İS55	30-0036.0006	36	8	15
İS55	30-0038.0007	38	7	25
İS55	30-0040.0008	40	10	18
İS55	30-0050.0009	50	10	18
İS55	30-0060.0010	60	10	18
İS55	30-0063.0011	63	12	22
İS55	30-0070.0012	70	12	22
İS55	30-0075.0013	75	15	22
İS55	30-0080.0014	80	16	25
İS55	30-0090.0015	90	16	25
İS55	30-0100.0016	100	16	25
İS55	30-0110.0017	110	18	25
İS55	30-0125.0018	125	20	30
İS55	30-0140.0019	140	20	30
İS55	30-0150.0020	150	20	30
İS55	30-0160.0021	160	27	31
İS55	30-0180.0022	180	27	31
İS55	30-0190.0023	190	20	30
İS55	30-0200.0024	200	27	35
İS55	30-0250.0025	250	30	35
İS55	30-0320.0026	320	36	40

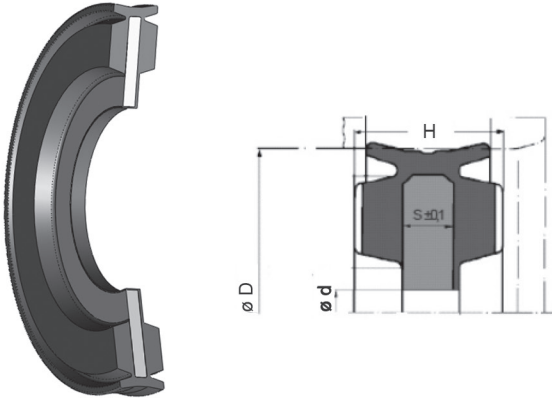

KISA TİP PNÖMATİK PİSTON KEÇESİ
İS56

TİP	REF. NO	ø D	ø d	B
İS56	32-0020.0001	20	7	8,8
İS56	32-0020.0002	25	7	8,8
İS56	32-0020.0003	32	8	11
İS56	32-0020.0006	40	8	11,8
İS56	32-0020.0007	50	10	14
İS56	32-0020.0009	63	12	14
İS56	32-0020.0011	80	16	16
İS56	32-0020.0013	100	20	18

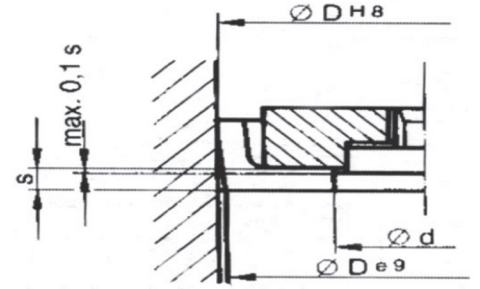
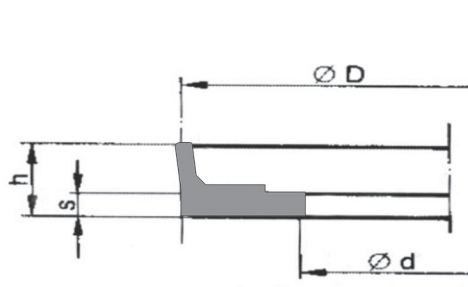

TEK YÖNLÜ PİSTON KEÇESİ İS58				
TİP	REF. NO	ø D	ø d	B
İS58	31-0007.0028	7,5	4	3
İS58	31-0008.0009	8,5	6,5	2,2
İS58	31-0009.0064	9	5	4
İS58	31-0012.0093	12	4,5	3,5
İS58	31-0015.0031	15	-	7
İS58	31-0015.0057	25	15	6
İS58	31-0016.0013	16	-	6,5
İS58	31-0016.0062	16	-	10
İS58	31-0018.0029	18	13,5	3,3
İS58	31-0019.0097	19,5	11	6
İS58	31-0020.0117	20	-	6
İS58	31-0020.0019	20	11	6
İS58	31-0020.0030	20	11	6,5
İS58	31-0020.0020	20	11	9
İS58	31-0020.0099	20	12	7
İS58	31-0021.0014	21	-	8,3
İS58	31-0021.0040	21	-	9
İS58	31-0022.0001	22	11	6
İS58	31-0022.0096	22	-	5,8
İS58	31-0022.0058	22	-	6
İS58	31-0022.0025	22,5	-	8,5
İS58	31-0023.0091	23	-	6,5
İS58	31-0023.0051	23,5	20,3	6,5
İS58	31-0025.0041	25	-	4,5
İS58	31-0025.0055	25	-	5
İS58	31-0025.0035	25	-	6
İS58	31-0026.0039	26	-	6
İS58	31-0026.0033	26	-	5,5
İS58	31-0029.0090	29	14,5	6
İS58	31-0029.0092	29,8	15,5	10
İS58	31-0030.0037	30	-	7
İS58	31-0031.0069	31,5	-	12
İS58	31-0032.0054	32	-	8

TEK YÖNLÜ PİSTON KEÇESİ İS58				
TİP	REF. NO	ø D	ø d	B
İS58	31-0034.0043	34	-	7,5
İS58	31-0034.0075	34,5	-	9
İS58	31-0035.0056	35	22	7
İS58	31-0036.0095	36	-	8
İS58	31-0036.0100	36	12	9,5
İS58	31-0036.0003	36	22	7
İS58	31-0036.0012	36,5	15,5	9,5
İS58	31-0036.0076	36,7	26,5	7
İS58	31-0037.0116	37	22	7
İS58	31-0037.0087	37	29,5	6,8
İS58	31-0038.0098	38	26	6
İS58	31-0038.0094	38	-	7,8
İS58	31-0038.0006	38,5	14,5	5,5
İS58	31-0038.0017	38,1	22,5	7,5
İS58	31-0038.0032	38	25,5	7
İS58	31-0039.0086	39,3	-	9,5
İS58	31-0040.0068	40	-	7
İS58	31-0040.0036	40	-	8
İS58	31-0040.0063	40	10	12
İS58	31-0040.0011	40	15,7	11
İS58	31-0040.0021	40	18	15
İS58	31-0040.0022	40	18	15
İS58	31-0040.0045	40	22	7,5
İS58	31-0040.0004	40	27	4,5
İS58	31-0040.0059	40	30	7
İS58	31-0040.0049	40,5	14	8,5
İS58	31-0041.0089	41	25	7
İS58	31-0041.0048	41,5	-	8
İS58	31-0043.0042	43	35	5
İS58	31-0043.0026	43	15,5	9,5
İS58	31-0044.0074	44	16	9,5
İS58	31-0044.0078	44	25,5	7
İS58	31-0044.0085	44	28	18

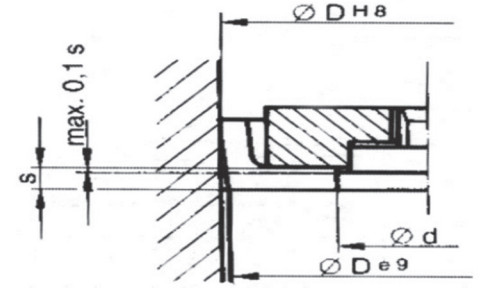
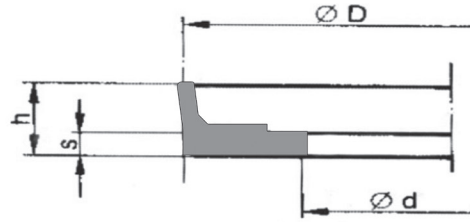
**TEK YÖNLÜ PİSTON KEÇESİ
İS58**

TİP	REF. NO	ø D	ø d	B
İS58	31-0044.0046	44,5	25,5	7,5
İS58	31-0045.0102	45	17	12
İS58	31-0045.0018	45	25	8
İS58	31-0047.0005	47	30,5	8
İS58	31-0048.0101	48	34	20
İS58	31-0059.0084	49,8	-	10
İS58	31-0050.0016	50	-	7
İS58	31-0050.0002	50	-	14,5
İS58	31-0050.0038	50	10	12
İS58	31-0050.0047	50	34	9,5
İS58	31-0050.0052	50	38	7
İS58	31-0050.0060	50	115	13
İS58	31-0051.0050	51	35	18
İS58	31-0055.0073	55	25	20
İS58	31-0055.0118	55	37	7
İS58	31-0056.0067	56	-	13,5
İS58	31-0056.0044	56	-	18
İS58	31-0058.0027	58	35	15,5
İS58	31-0060.0071	60	27	13
İS58	31-0065.0083	65	33,8	20
İS58	31-0069.0008	69,5	20	16
İS58	31-0075.0034	75	56	14
İS58	31-0079.0077	79,4	30,5	13,5
İS58	31-0080.0015	80	41	11
İS58	31-0080.0024	80	49,5	13
İS58	31-0086.0082	86,9	53,97	17
İS58	31-0087.0065	87	64	10
İS58	31-0092.0066	92	65	12
İS58	31-0101.0080	101,6	61,5	13
İS58	31-0105.0053	105	97	21
İS58	31-0109.0081	109	89	6,5
İS58	31-0110.0023	110	50	14,5
İS58	31-0110.0007	110	50	12,5

**TEK YÖNLÜ PİSTON KEÇESİ
İS58**

TİP	REF. NO	ø D	ø d	B
İS58	31-0110.0072	110	60	15
İS58	31-0113.0115	113,5	48	15,3
İS58	31-0115.0060	115	50	13
İS58	31-0120.0010	120	85	15
İS58	31-0124.0061	124	100	12
İS58	31-0139.0079	139,7	64,5	14
İS58	31-0164.0104	164	122	22
İS58	31-0239.0070	239	178	16
İS58	31-0249.0105	249	210	16
İS58	31-0300.0103	300	180	15
İS58	31-0300.0106	300	170	25
İS58	31-0395.0119	395	340	30
İS58	31-0300.0107	400	270	30

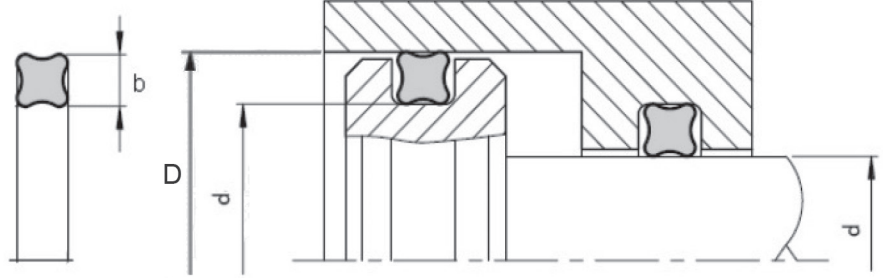

X-RİNG İS51				
TİP	REF. NO	$\varnothing d$	$\varnothing D$	B
İS51	38-0007.0042	7	12	3
İS51	38-0008.0008	8	-	1,8
İS51	38-0008.0028	8	14	2
İS51	38-0008.0029	8,5	11	2
İS51	38-0010.0027	10	-	3
İS51	38-0010.0075	10	15	2,7
İS51	38-0011.0011	11,7	-	1,5
İS51	38-0012.0109	12	-	2,6
İS51	38-0012.0053	12,5	-	2,5
İS51	38-0013.0034	13,5	-	2,5
İS51	38-0014.0018	14,5	-	2,75
İS51	38-0016.0007	16	-	2,5
İS51	38-0016.0013	16	-	3
İS51	38-0018.0085	18,64	-	3,53
İS51	38-0019.0035	19	-	2,5
İS51	38-0019.0005	19,05	-	3,53
İS51	38-0020.0039	20	-	1,5
İS51	38-0020.0004	20,22	-	3,5
İS51	38-0020.0043	20,5	-	3,5
İS51	38-0021.0012	21,5	-	3,5
İS51	38-0022.0030	22	-	3,5
İS51	38-0022.0065	22	30	3,5
İS51	38-0023.0059	23	-	6
İS51	38-0025.0016	25	-	4,5
İS51	38-0025.0040	25	30	5,1
İS51	38-0025.0087	25	32	5
İS51	38-0025.0072	25,4	-	3,53
İS51	38-0026.0047	26	33	5,5
İS51	38-0028.0025	28	-	3,5
İS51	38-0028.0052	28,17	-	3,53
İS51	38-0028.0037	28	-	5
İS51	38-0030.0021	30	40	3,5
İS51	38-0033.0015	33	-	3

X-RİNG İS51				
TİP	REF. NO	$\varnothing d$	$\varnothing D$	B
İS51	38-0033.0014	33,4	-	3,53
İS51	38-0034.0022	34,5	-	3,53
İS51	38-0035.0032	35,73	-	3,53
İS51	38-0037.0006	37,5	-	3,5
İS51	38-0038.0003	38,1	-	3,53
İS51	38-0039.0064	39,5	49,5	5,5
İS51	38-0040.0065	40	50	3,8
İS51	38-0044.0050	44,5	54,5	5,5
İS51	38-0045.0078	45	-	5,5
İS51	38-0045.0023	45,5	-	3,5
İS51	38-0048.0009	48	-	5,5
İS51	38-0050.0031	50	-	5
İS51	38-0050.0038	50	-	6
İS51	38-0050.0073	50,4	-	5,33
İS51	38-0053.0051	53	-	3,5
İS51	38-0055.0077	55	-	5
İS51	38-0056.0083	56,52	-	5,33
İS51	38-0057.0081	57	-	4,5
İS51	38-0057.0036	57	-	5,5
İS51	38-0059.0045	59,7	-	5,33
İS51	38-0060.0017	60	70	5,5
İS51	38-0065.0076	65	-	2,5
İS51	38-0065.0084	65,5	-	7
İS51	38-0066.0010	66	-	5,5
İS51	38-0069.0024	69	-	2,5
İS51	38-0069.0057	69,22	-	5,33
İS51	38-0072.0049	72,75	-	3,53
İS51	38-0072.0074	72,75	-	5,33
İS51	38-0078.0082	78,74	-	5,33
İS51	38-0082.0044	82	89	5,1
İS51	38-0084.0113	84,5	-	3,5
İS51	38-0085.0080	85,09	-	5,33
İS51	38-0086.0033	86	-	6

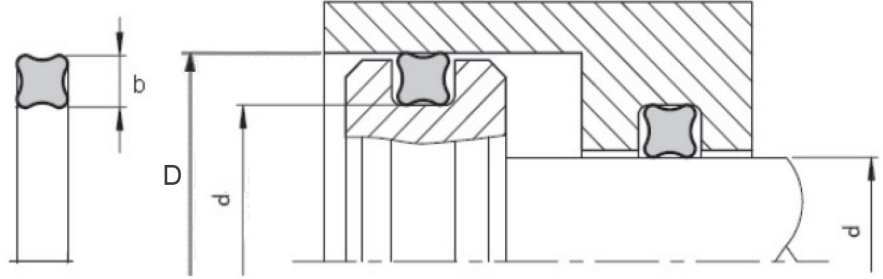

**X-RİNG
İS51**

TİP	REF. NO	$\varnothing d$	$\varnothing D$	B
İS51	38-0089.0057	89,32	-	5,34
İS51	38-0091.0040	91	98	5,1
İS51	38-0100.0019	100	-	5
İS51	38-0101.0044	101	108	5,1
İS51	38-0104.0112	104	-	5
İS51	38-0106.0113	106	-	3
İS51	38-0110.0088	110	-	5
İS51	38-0111.0057	111	-	7
İS51	38-0118.0002	118	-	5
İS51	38-0120.0046	120	-	6,5
İS51	38-0120.0071	120	-	7
İS51	38-0124.0026	124	-	3,5
İS51	38-0126.0048	126	139,6	6
İS51	38-0128.0001	128	-	5
İS51	38-0129.0108	129,5	-	7
İS51	38-0135.0058	135	-	6,5
İS51	38-0148.0079	148,59	-	7
İS51	38-0155.0033	155	-	7,2
İS51	38-0173.0070	173	-	6,5
İS51	38-0175.0041	175	-	5
İS51	38-0185.0041	185	-	5
İS51	38-0190.0111	190,98	-	6,3
İS51	38-0199.0067	199,2	216,2	7,8
İS51	38-0200.0069	200	-	7
İS51	38-0200.0066	200	216,5	7,8
İS51	38-0217.0068	217	-	7
İS51	38-0227.0088	227	-	7
İS51	38-0290.0020	290	-	6,35
İS51	38-0292.0090	292	-	7
İS51	38-0310.0107	310	-	7
İS51	38-0350.0108	350	-	7

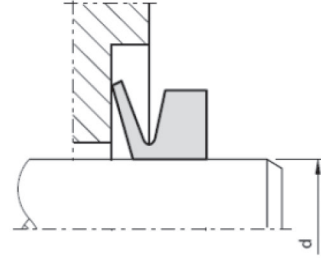
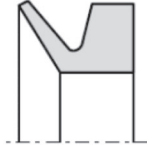
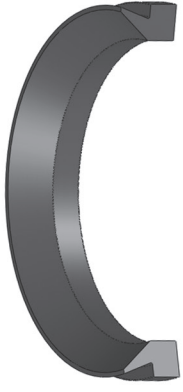

V-RİNG A İS48		
TİP	REF. NO	ÖLÇÜ
		$\emptyset d$
İS48	39-0035.0004	Q35
İS48	39-0040.0026	Q40
İS48	39-0045.0017	Q45
İS48	39-0070.0003	Q70
İS48	39-0085.0042	Q85
İS48	39-0100.0013	Q100
İS48	39-0110.0014	Q110
İS48	39-0130.0015	Q130
İS48	39-0140.0029	Q140
İS48	39-0150.0041	Q150
İS48	39-0160.0030	Q160
İS48	39-0170.0031	Q170
İS48	39-0180.0011	Q180
İS48	39-0190.0009	Q190
İS48	39-0220.0044	Q200
İS48	39-0220.0032	Q220
İS48	39-0240.0027	Q240
İS48	39-0250.0028	Q250
İS48	39-0290.0043	Q290
İS48	39-0325.0036	Q325
İS48	39-0400.0035	Q400

V-RİNG A İS48		
TİP	REF. NO	ÖLÇÜ
		$\emptyset d$

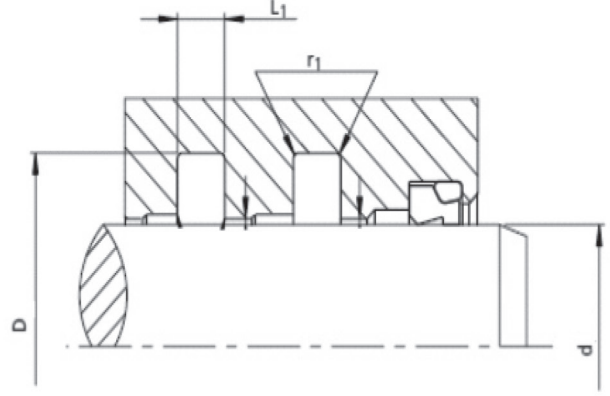

ROD OMEGAT 1 İS61				
TİP	REF. NO	$\varnothing d$	$\varnothing D$	B
İS61	50-0005.2001	5	9,9	2,2
İS61	50-0006.2002	6	10,9	2,2
İS61	50-0007.2003	7	11,9	2,2
İS61	50-0008.2004	8	12,9	2,2
İS61	50-0008.3005	8	15,3	3,2
İS61	50-0010.2006	10	14,9	2,2
İS61	50-0010.3007	10	17,3	3,2
İS61	50-0012.3008	12	19,3	3,2
İS61	50-0014.3009	14	21,3	3,2
İS61	50-0015.2010	15	19,9	2,2
İS61	50-0015.3011	15	22,3	3,2
İS61	50-0016.2012	16	20,9	2,2
İS61	50-0016.3013	16	23,3	3,2
İS61	50-0018.2014	18	22,9	2,2
İS61	50-0018.3015	18	25,3	3,2
İS61	50-0020.3016	20	27,3	3,2
İS61	50-0020.4017	20	30,7	4,2
İS61	50-0022.3018	22	29,3	3,2
İS61	50-0022.4019	22	32,7	4,2
İS61	50-0025.3020	25	32,3	3,2
İS61	50-0025.4021	25	35,7	4,2
İS61	50-0028.3022	28	35,3	3,2
İS61	50-0028.4023	28	38,7	4,2
İS61	50-0030.3024	30	37,3	3,2
İS61	50-0030.4025	30	40,7	4,2
İS61	50-0032.3026	32	39,3	3,2
İS61	50-0032.4027	32	42,7	4,2
İS61	50-0035.3028	35	42,3	3,2
İS61	50-0035.4029	35	45,7	4,2
İS61	50-0036.3031	36	43,3	3,2
İS61	50-0036.4032	36	46,7	4,2
İS61	50-0038.4033	38	48,7	4,2
İS61	50-0038.6034	38	53,1	6,3

ROD OMEGAT 1 İS61				
TİP	REF. NO	$\varnothing d$	$\varnothing D$	B
İS61	50-0040.4035	40	50,7	4,2
İS61	50-0040.6036	40	55,1	6,3
İS61	50-0042.4037	42	52,7	4,2
İS61	50-0042.6038	42	57,1	6,3
İS61	50-0045.6039	45	60,1	6,3
İS61	50-0050.4040	50	60,7	4,2
İS61	50-0050.6041	50	65,1	6,3
İS61	50-0055.4042	55	65,7	4,2
İS61	50-0055.6043	55	70,1	6,3
İS61	50-0056.4044	56	66,7	4,2
İS61	50-0056.6045	56	71,1	6,3
İS61	50-0060.4046	60	70,1	4,2
İS61	50-0060.6047	60	75,1	6,3
İS61	50-0063.4048	63	73,7	4,2
İS61	50-0063.6049	63	78,1	6,3
İS61	50-0065.4050	65	75	7X4,2
İS61	50-0065.6051	65	80,1	6,3
İS61	50-0070.4052	70	80,7	4,2
İS61	50-0070.6053	70	85,1	6,3
İS61	50-0075.4054	75	85,7	4,2
İS61	50-0075.6055	75	90,1	6,3
İS61	50-0080.4056	80	90,7	4,2
İS61	50-0080.6057	80	95,1	6,3
İS61	50-0085.6058	85	100,1	6,3
İS61	50-0090.6059	90	105,1	6,3
İS61	50-0095.6060	95	110,1	6,3
İS61	50-0100.6061	100	115,1	6,3
İS61	50-0100.6062	105	120,1	6,3
İS61	50-0110.6063	110	125,1	6,3
İS61	50-0115.6064	115	130,1	6,3
İS61	50-0120.6065	120	135,1	6,3
İS61	50-0125.6066	125	140,1	6,3
İS61	50-0125.8067	125	145,5	8,1

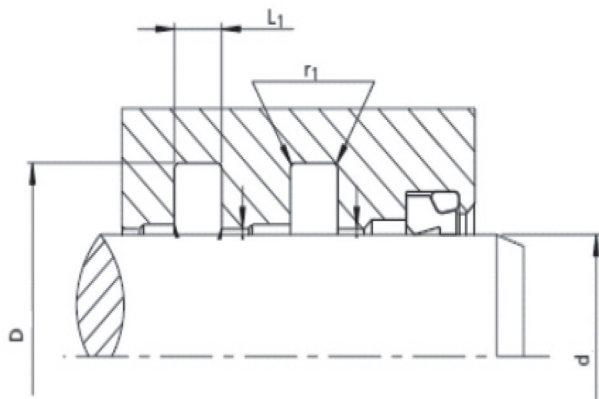

ROD OMEGAT 1 İS61				
TİP	REF. NO	Ø d	Ø D	B
İS61	50-0130.6068	130	145,1	6,3
İS61	50-0130.8069	130	150,5	8,1
İS61	50-0135.6070	135	150,1	6,3
İS61	50-0135.6071	140	155,1	6,3
İS61	50-0140.8072	140	160,5	8,1
İS61	50-0140.6073	145	160,1	6,3
İS61	50-0145.8074	145	165,5	8,1
İS61	50-0145.6075	150	165,1	6,3
İS61	50-0150.8076	150	170,5	8,1
İS61	50-0160.6077	160	175,1	6,3
İS61	50-0160.8078	160	180,5	8,1
İS61	50-0170.6079	170	185,1	6,3
İS61	50-0170.8080	170	190,5	8,1
İS61	50-0180.6081	180	195,1	6,3
İS61	50-0180.8082	180	200,5	8,1
İS61	50-0190.6083	190	205,1	6,3
İS61	50-0130.8084	190	210,5	8,1
İS61	50-0200.8085	200	215,1	6,3
İS61	50-0200.8086	200	220,5	8,1
İS61	50-0210.8087	210	230,5	8,1
İS61	50-0215.8088	215	235,5	8,1
İS61	50-0220.8089	220	240,5	8,1
İS61	50-0225.8090	225	245,5	8,1
İS61	50-0230.8091	230	250,5	8,1
İS61	50-0240.8092	240	260,5	8,1
İS61	50-0250.8093	250	270,5	8,1
İS61	50-0260.8094	260	284	8,1
İS61	50-0270.8095	270	294	8,1
İS61	50-0275.8096	275	299	8,1
İS61	50-0280.8097	280	304	8,1
İS61	50-0290.8098	290	314	8,1
İS61	50-0300.8099	300	324	8,1
İS61	50-0310.8100	310	334	8,1

ROD OMEGAT 1 İS61				
TİP	REF. NO	Ø d	Ø D	B
İS61	50-0320.8101	320	344	8,1
İS61	50-0330.8102	330	354	8,1
İS61	50-0340.8103	340	364	8,1
İS61	50-0350.8104	350	374	8,1
İS61	50-0360.8105	360	384	8,1
İS61	50-0370.8106	370	394	8,1
İS61	50-0380.8107	380	404	8,1
İS61	50-0390.8108	390	414	8,1
İS61	50-0400.8109	400	424	8,1
İS61	50-0420.8110	420	444,5	8,1
İS61	50-0430.8111	430	454,5	8,1
İS61	50-0440.8112	440	464,5	8,1
İS61	50-0450.8113	450	474,5	8,1
İS61	50-0460.8114	460	484,5	8,1
İS61	50-0470.8115	470	494,5	8,1
İS61	50-0480.8116	480	504,5	8,1
İS61	50-0500.8117	500	524,5	8,1

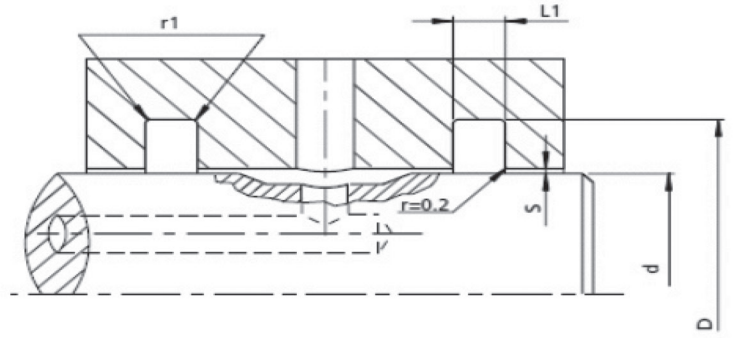
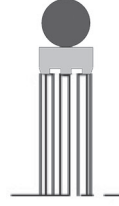

ROD DÖNER KEÇE İS64				
TİP	REF. NO	$\varnothing d$	$\varnothing D$	B
İS64	52-0008.0001	8	12,9	2,2
İS64	52-0010.2002	10	14,9	2,2
İS64	52-0010.3003	10	17,5	3,2
İS64	52-0015.2004	15	19,9	2,2
İS64	52-0015.3005	15	22,5	3,2
İS64	52-0020.0006	20	27,5	3,2
İS64	52-0025.0007	25	32,5	3,2
İS64	52-0030.0008	30	37,5	3,2
İS64	52-0035.0009	35	42,5	3,2
İS64	52-0040.0010	40	51	4,2
İS64	52-0045.0011	45	56	4,2
İS64	52-0050.4012	50	61	4,2
İS64	52-0050.6013	50	65,5	6,3
İS64	52-0055.0014	55	66	4,2
İS64	52-0060.4015	60	71	4,2
İS64	52-0060.6016	60	75,5	6,3
İS64	52-0065.0017	65	76	4,2
İS64	52-0070.4018	70	81	4,2
İS64	52-0070.6019	70	85,5	6,3
İS64	52-00750020	75	86	4,2
İS64	52-0080.4021	80	91	4,2
İS64	52-0080.6022	80	95,5	6,3
İS64	52-0085.0023	85	96	4,2
İS64	52-0090.4024	90	101	4,2
İS64	52-0090.6025	90	105,5	6,3
İS64	52-0095.0026	95	106	4,2
İS64	52-0100.0027	100	111	4,2
İS64	52-0100.6028	100	115,5	6,3
İS64	52-0105.0029	105	116	4,2
İS64	52-0110.0030	110	121	4,2
İS64	52-0110.0031	110	125,5	6,3
İS64	52-0115.0032	115	126	4,2
İS64	52-0120.0033	120	131	4,2

ROD DÖNER KEÇE İS64				
TİP	REF. NO	$\varnothing d$	$\varnothing D$	B
İS64	52-0120.0034	120	135,5	6,3
İS64	52-0125.0035	125	136	4,2
İS64	52-0125.0036	125	140,5	6,3
İS64	52-0130.0037	130	141	4,2
İS64	52-0135.0038	135	146	4,2
İS64	52-0140.0039	140	151	4,2
İS64	52-0140.0040	140	155,5	6,3
İS64	52-0145.0041	145	156	4,2
İS64	52-0145.0042	145	160,5	6,3
İS64	52-0150.0043	150	161	4,2
İS64	52-0150.0044	150	165,5	6,3
İS64	52-0160.0045	160	171	4,2
İS64	52-0160.0046	160	175,5	6,3
İS64	52-0170.0047	170	181	4,2
İS64	52-0170.0048	170	185,5	6,3
İS64	52-0180.0049	180	191	4,2
İS64	52-0180.0050	180	195,5	6,3
İS64	52-0190.0051	190	201	4,2
İS64	52-0190.0052	190	205,5	6,3
İS64	52-0200.0053	200	215,5	6,3
İS64	52-0210.0054	210	225,5	6,3
İS64	52-0220.0055	220	235,5	6,3
İS64	52-0230.0056	230	245,5	6,3
İS64	52-0240.0057	240	255,5	6,3
İS64	52-0250.0058	250	265,5	6,3

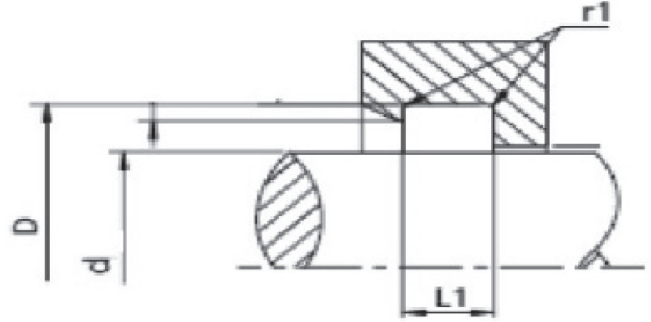
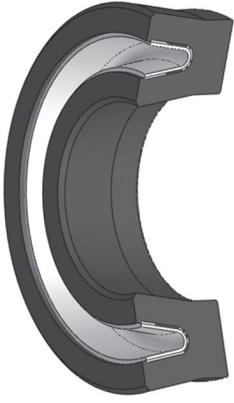

**U YAYLI PTFE ROD KEÇESİ
İS63**

TİP	REF. NO	ø d	ø D	B
İS63	46-0015.0001	15	19,5	3,6
İS63	46-0020.0002	20	26,2	4,8
İS63	46-0025.0003	25	31,2	4,8
İS63	46-0030.0004	30	36,2	4,8
İS63	46-0035.0005	35	41,2	4,8
İS63	46-0040.0006	40	49,4	7,1
İS63	46-0045.0007	45	54,4	7,1
İS63	46-0050.0008	50	59,4	7,1
İS63	46-0055.0009	55	64,4	7,1
İS63	46-0060.0010	60	69,4	7,1
İS63	46-0063.0011	63	72,4	7,1
İS63	46-0070.0012	70	79,4	7,1
İS63	46-0075.0013	75	84,4	7,1
İS63	46-0080.0014	80	89,4	7,1
İS63	46-0085.0015	85	94,4	7,1
İS63	46-0090.0016	90	99,4	7,1
İS63	46-0100.0017	100	109,4	7,1
İS63	46-0110.0018	110	119,4	7,1
İS63	46-0115.0019	115	124,4	7,1
İS63	46-0120.0020	120	132,5	9,5
İS63	46-0125.0021	125	137,5	9,5
İS63	46-0130.0022	130	142,5	9,5
İS63	46-0140.0023	140	152,5	9,5
İS63	46-0150.0024	150	162,2	9,5
İS63	46-0160.0025	160	172,2	9,5
İS63	46-0180.0026	180	192,2	9,5
İS63	46-0200.0027	200	212,2	9,5

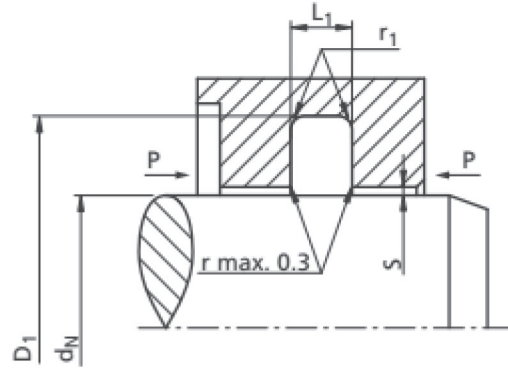
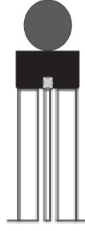
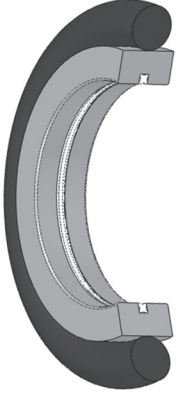

ROD OMEGAT 2 İS62				
TİP	REF. NO	$\emptyset d$	$\emptyset D$	B
İS62	53-0020.0001	20	30,7	4,2
İS62	53-0022.0002	22	32,7	4,2
İS62	53-0025.0003	25	35,7	4,2
İS62	53-0028.0004	28	38,7	4,2
İS62	53-0030.0005	30	40,7	4,2
İS62	53-0032.0006	32	42,7	4,2
İS62	53-0035.0007	35	45,7	4,2
İS62	53-0036.0008	36	46,7	4,2
İS62	53-0040.0009	40	50,7	4,2
İS62	53-0045.0010	45	55,7	4,2
İS62	53-0050.0011	50	60,7	4,2
İS62	53-0055.0012	55	65,7	4,2
İS62	53-0060.0013	60	70,7	4,2
İS62	53-0063.0014	63	73,7	4,2
İS62	53-0063.0015	63	78,1	6,3
İS62	53-0070.0016	70	80,7	4,2
İS62	53-0070.0017	70	85,1	6,3
İS62	53-0080.0018	80	95,1	6,3
İS62	53-0090.0019	90	105,1	6,3
İS62	53-0090.0020	90	110,5	8,1
İS62	53-0100.0021	100	115,1	6,3
İS62	53-0100.0022	100	120,5	8,1
İS62	53-0110.0023	110	125,1	6,3
İS62	53-0110.0024	110	130,5	8,1
İS62	53-0120.0025	120	135,1	6,3
İS62	53-0120.0026	120	140,5	8,1
İS62	53-0125.0027	125	145,5	8,1
İS62	53-0130.0028	130	150,5	8,1
İS62	53-0140.0029	140	160,5	8,1
İS62	53-0150.0030	150	170,5	8,1
İS62	53-0160.0031	160	180,5	8,1
İS62	53-0180.0032	180	200,5	8,1
İS62	53-0200.0033	200	220,5	8,1

ROD OMEGAT 2 İS62				
TİP	REF. NO	$\emptyset d$	$\emptyset D$	B
İS62	53-0220.0034	220	240,5	8,1
İS62	53-0250.0035	250	270,5	8,1

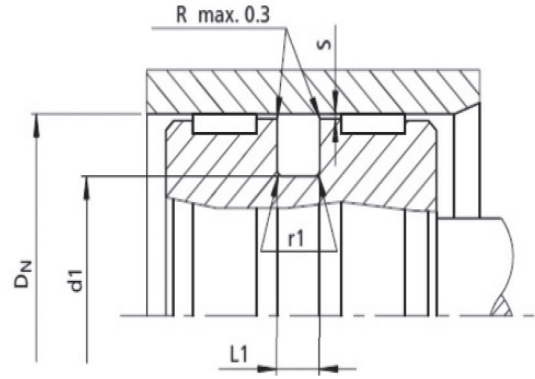
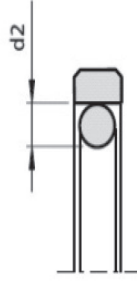

**PİSTON OMEGAT 1
İS70**

TİP	REF. NO	$\varnothing D$	$\varnothing d$	B
İS70	51-0008.0001	8	3,1	2,2
İS70	51-0010.0010	10	5,1	2,2
İS70	51-0012.0012	12	7,1	2,2
İS70	51-0015.0015	15	7,5	3,2
İS70	51-0015.1016	15	10,1	2,2
İS70	51-0016.1017	16	8,5	3,2
İS70	51-0016.2018	16	11,1	2,2
İS70	51-0018.1019	18	10,5	3,2
İS70	51-0018.2020	18	13,1	2,2
İS70	51-0020.1021	20	12,5	3,2
İS70	51-0020.2022	20	15,1	2,2
İS70	51-0022.1023	22	14,5	3,2
İS70	51-0022.2024	22	17,1	2,2
İS70	51-0024.0025	24	16,5	3,2
İS70	51-0025.1026	25	14	4,2
İS70	51-0025.2027	25	17,5	3,2
İS70	51-0025.3028	25	20,1	2,2
İS70	51-0028.1029	28	20,5	3,2
İS70	51-0028.2030	28	23,1	2,2
İS70	51-0030.1031	30	22,5	3,2
İS70	51-0030.2032	30	25,1	2,2
İS70	51-0032.1033	32	21	4,2
İS70	51-0032.2034	32	24,5	3,2
İS70	51-0032.3035	32	27,1	2,2
İS70	51-0035.1036	35	24	4,2
İS70	51-0035.2037	35	27,5	3,2
İS70	51-0036.1038	36	25	4,2
İS70	51-0036.2039	36	28,5	3,2
İS70	51-0040.1040	40	29	4,2
İS70	51-0040.2041	40	32,5	3,2
İS70	51-0042.0042	42	31	4,2
İS70	51-0045.0043	45	34	4,2
İS70	51-0050.0044	50	39	4,2

**PİSTON OMEGAT 1
İS70**

TİP	REF. NO	$\varnothing D$	$\varnothing d$	B
İS70	51-0055.0045	55	44	4,2
İS70	51-0056.0046	56	45	4,2
İS70	51-0060.0047	60	49	4,2
İS70	51-0063.1048	63	47,5	6,3
İS70	51-0063.2049	63	52	4,2
İS70	51-0065.1050	65	49,5	6,3
İS70	51-0065.2051	65	54	4,2
İS70	51-0070.1052	70	54,5	6,3
İS70	51-0070.2053	70	59	4,2
İS70	51-0075.1054	75	59,5	6,3
İS70	51-0075.2055	75	64	4,2
İS70	510-080.1056	80	59	8,1
İS70	51-0080.2057	80	64,5	6,3
İS70	51-0080.3058	80	69	4,2
İS70	51-0085.1059	85	64	8,1
İS70	51-0085.2060	85	69,5	6,3
İS70	51-0090.1061	90	69	8,1
İS70	51-0090.2062	90	74,5	6,3
İS70	51-0090.3063	90	79	4,2
İS70	51-0095.0064	95	74	8,1
İS70	51-0100.1065	100	79	8,1
İS70	51-0100.2066	100	84,5	6,3
İS70	51-0100.3067	100	89	4,2
İS70	51-0105.1068	105	84	8,1
İS70	51-0105.2069	105	89,5	6,3
İS70	51-0110.1070	110	89	8,1
İS70	51-0110.2071	110	94,5	6,3
İS70	51-0110.3072	110	99	4,2
İS70	51-0115.1073	115	94	8,1
İS70	51-0115.2074	115	99,5	6,3
İS70	51-0120.1075	120	99	8,1
İS70	51-0120.2076	120	104,5	6,3
İS70	51-0120.3077	120	109	4,2

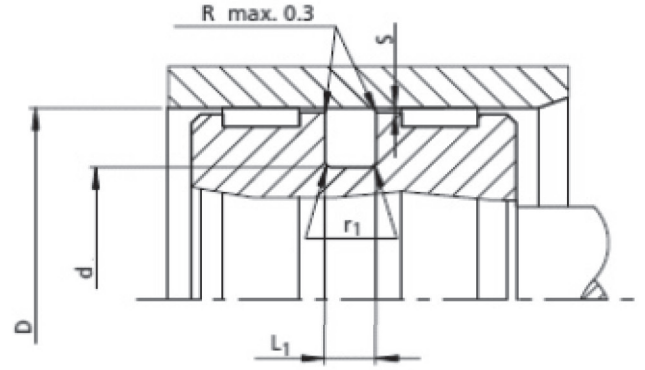
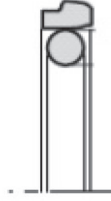

**TEK ETKİLİ PİSTON OMEGAT 2
İS71**

TİP	REF. NO	ø D	ø d	B
İS71	48-0015.0001	15	10,1	2,2
İS71	48-0016.0002	16	11,1	2,2
İS71	48-0018.0003	18	10,7	3,2
İS71	48-0020.0004	20	12,7	3,2
İS71	48-0022.0005	22	14,7	3,2
İS71	48-0025.4006	25	14,3	4,2
İS71	48-0025.3007	25	17,7	3,2
İS71	48-0028.0008	28	17,3	4,2
İS71	48-0030.4009	30	19,3	4,2
İS71	48-0030.3010	30	22,7	3,2
İS71	48-0032.4011	32	21,3	4,2
İS71	48-0032.3012	32	24,7	3,2
İS71	48-0035.3013	35	24,3	4,2
İS71	48-0035.4014	35	27,7	3,2
İS71	48-0036.4015	36	25,3	4,2
İS71	48-0036.3016	36	28,7	3,2
İS71	48-0040.0017	40	29,3	4,2
İS71	48-0040.0018	42	31,3	4,2
İS71	48-0045.0019	45	34,3	4,2
İS71	48-0050.0020	50	39,3	4,2
İS71	48-0055.0021	55	44,3	4,2
İS71	48-0056.0022	56	45,3	4,2
İS71	48-0060.6023	60	44,9	6,3
İS71	48-0060.4024	60	49,3	4,2
İS71	48-0063.4025	63	47,9	6,3
İS71	48-0063.4026	63	52,3	4,2
İS71	48-0065.0027	65	49,9	6,3
İS71	48-0070.6028	70	54,9	6,3
İS71	48-0070.4029	70	59,3	4,2
İS71	48-0075.0030	75	59,9	6,3
İS71	48-0080.0031	80	64,9	6,3
İS71	48-0090.0032	90	74,9	6,3

**TEK ETKİLİ PİSTON OMEGAT 2
İS71**

TİP	REF. NO	ø D	ø d	B
İS71	48-0095.0033	95	79,9	6,3
İS71	48-0100.0034	100	84,9	6,3
İS71	48-0105.0035	105	89,9	6,3
İS71	48-0110.0036	110	94,9	6,3
İS71	48-0115.0037	115	99,9	6,3
İS71	48-0120.8038	120	99,5	8,1
İS71	48-0120.6039	120	104,9	6,3
İS71	48-0125.8040	125	104,5	8,1
İS71	48-0125.6041	125	109,9	6,3
İS71	48-0130.8042	130	109,5	8,1
İS71	48-0130.6043	130	114,9	6,3
İS71	48-0140.8044	140	119,5	8,1
İS71	48-0140.6045	140	124,9	6,3
İS71	48-0150.8046	150	129,5	8,1
İS71	48-0150.6047	150	134,9	6,3
İS71	48-0160.8048	160	139,5	8,1
İS71	48-0160.6049	160	144,9	6,3
İS71	48-0170.8050	170	149,5	8,1
İS71	48-0170.6051	170	154,9	6,3
İS71	48-0180.8052	180	159,5	8,1
İS71	48-0180.6053	180	164,9	6,3
İS71	48-0190.8054	190	169,5	8,1
İS71	48-0190.6055	190	174,9	6,3
İS71	48-0200.0056	200	179,5	8,1
İS71	48-0210.0057	210	189,5	8,1
İS71	48-0220.0058	220	199,5	8,1
İS71	48-0230.0059	230	209,5	8,1
İS71	48-0240.0060	240	219,5	8,1
İS71	48-0250.0061	250	229,5	8,1
İS71	48-0260.0062	260	236	8,1
İS71	48-0270.0063	270	246	8,1
İS71	48-0280.0064	280	256	8,1
İS71	48-0300.0065	300	276	8,1

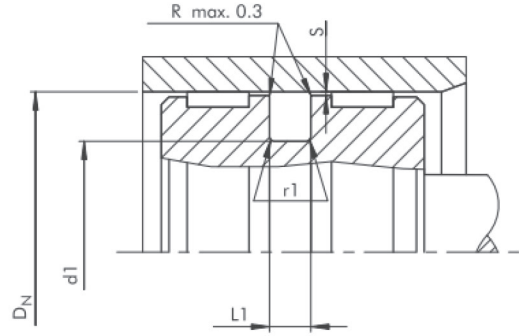

**SEGMAN TİP POM OMEGAT 4
İS77**

TİP	REF. NO	$\emptyset D$	$\emptyset d$	B
İS77	62-0060.0001	60	44,5	6,3
İS77	63-0063.0002	63	47,5	6,3
İS77	63-0070.0003	70	54,5	6,3
İS77	63-0080.0004	80	64,5	6,3
İS77	63-0090.0005	80	59	8,1
İS77	63-0100.0006	90	69	8,1
İS77	63-0100.0007	100	79	8,1
İS77	63-0110.0008	110	89	8,1
İS77	63-0110.0009	120	99	8,1
İS77	63-0120.0010	125	104	8,1
İS77	63-0125.0011	130	109	8,1
İS77	63-0140.0012	140	119	8,1
İS77	63-0150.0013	150	129	8,1
İS77	63-0160.0014	160	139	8,1
İS77	63-0180.0015	180	159	8,1
İS77	63-0200.0016	200	179	8,1
İS77	63-0220.0017	220	199	8,1
İS77	63-0250.0018	250	229	8,1

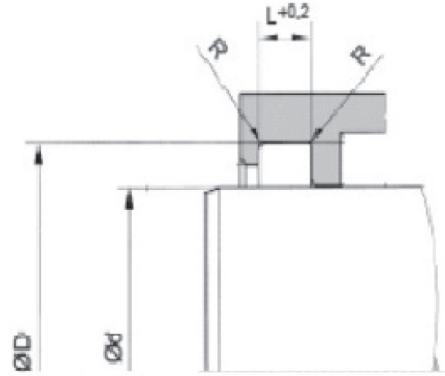

PTFE TOZ KEÇESİ İS38				
TİP	REF. NO	ø d	ø D	B
İS38	65-0010.0001	10	14,8	3,7
İS38	65-0012.0002	12	18,8	5
İS38	65-0014.0003	14	20,8	5
İS38	65-0015.0004	15	21,8	5
İS38	65-0016.0005	16	22,8	5
İS38	65-0018.0006	18	24,8	5
İS38	65-0020.0007	20	26,8	5
İS38	65-0025.0008	25	31,8	5
İS38	65-0028.0009	28	34,8	5
İS38	65-0030.0010	30	36,8	5
İS38	65-0032.0011	32	38,8	5
İS38	65-0035.0012	35	41,8	5
İS38	65-0036.0013	36	42,8	5
İS38	65-0040.0014	40	46,8	5
İS38	65-0042.0015	42	48,8	5
İS38	65-0045.0016	45	51,8	5
İS38	65-0050.0017	50	56,8	5
İS38	65-0055.0018	55	61,8	5
İS38	65-0056.0019	56	62,8	5
İS38	65-0060.0020	60	66,8	5
İS38	65-0063.0021	63	69,8	5
İS38	65-0065.0022	65	73,8	6
İS38	65-0070.0023	70	78,8	6
İS38	65-0075.0024	75	83,8	6
İS38	65-0080.0025	80	88,8	6
İS38	65-0085.0026	85	93,8	6
İS38	65-0090.0027	90	98,8	6
İS38	65-0095.0028	95	103,8	6
İS38	65-0100.0029	100	108,8	6
İS38	65-0110.0030	110	118,8	6
İS38	65-0120.0031	120	128,8	6
İS38	65-0125.0032	125	133,8	6
İS38	65-0130.0033	130	138,8	6

PTFE TOZ KEÇESİ İS38				
TİP	REF. NO	ø d	ø D	B
İS38	65-0140.0034	140	148,8	6
İS38	65-0150.0035	150	158,8	6
İS38	65-0160.0036	160	168,8	6
İS38	65-0170.0037	170	178,8	6
İS38	65-0180.0038	180	188,8	6
İS38	65-0190.0039	190	198,8	6
İS38	65-0200.0040	200	208,8	6
İS38	65-0220.0041	220	228,8	6
İS38	65-0240.0042	240	248,8	6
İS38	65-0250.0043	250	258,8	6

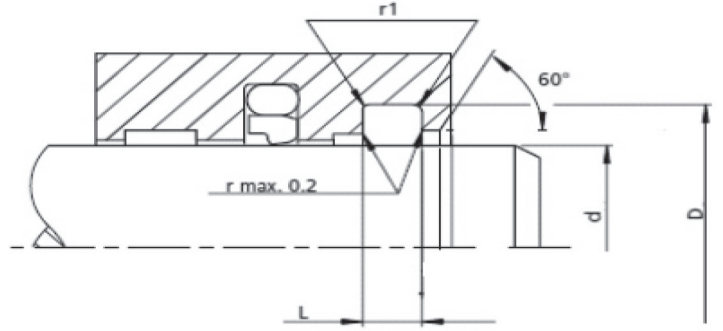
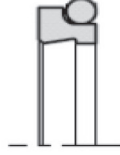
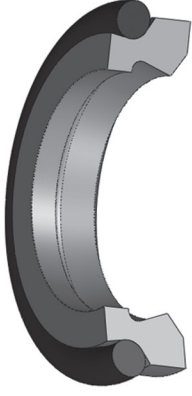

PTFE TOZ KEÇESİ İS39				
TİP	REF. NO	$\varnothing d$	$\varnothing D$	B
İS39	66-0010.0001	10	14,8	3,7
İS39	66-0012.0002	12	18,8	5
İS39	66-0014.0003	14	20,8	5
İS39	66-0015.0004	15	21,8	5
İS39	66-0016.0005	16	22,8	5
İS39	66-0018.0006	18	24,8	5
İS39	66-0020.0006	20	26,8	5
İS39	66-0025.5007	25	31,8	5
İS39	66-0025.4008	25	32,6	4,2
İS39	66-0028.0009	28	34,8	5
İS39	66-0030.0010	30	36,8	5
İS39	66-0032.0011	32	38,8	5
İS39	66-0035.0012	35	41,8	5
İS39	66-0036.0013	36	42,8	5
İS39	66-0040.0014	40	46,8	5
İS39	66-0042.0015	42	48,8	5
İS39	66-0045.0016	45	51,8	5
İS39	66-0050.5017	50	56,8	5
İS39	66-0050.6018	50	58,8	6,3
İS39	66-0055.5019	55	61,8	5
İS39	66-0055.6020	55	63,8	6,3
İS39	66-0056.5021	56	62,8	5
İS39	66-0056.6022	56	64,8	6,3
İS39	66-0060.5023	60	66,8	5
İS39	66-0060.6024	60	68,8	6,3
İS39	66-0063.5025	63	69,8	5
İS39	66-0063.6026	63	71,8	6,3
İS39	66-0065.0027	65	73,8	6,3
İS39	66-0070.6028	70	78,8	6,3
İS39	66-0070.8029	70	82,2	8,1
İS39	66-0075.6030	75	83,8	6,3
İS39	66-0075.8031	75	87,2	8,1
İS39	66-0080.6032	80	88,8	6,3

PTFE TOZ KEÇESİ İS39				
TİP	REF. NO	$\varnothing d$	$\varnothing D$	B
İS39	66-0080.8033	80	92,2	8,1
İS39	66-0085.6034	85	93,8	6,3
İS39	66-0085.8035	85	97,2	8,1
İS39	66-0090.6036	90	98,8	6,3
İS39	66-0090.8037	90	102,2	8,1
İS39	66-0095.6038	95	103,8	6,3
İS39	66-0095.8039	95	107,2	8,1
İS39	66-0100.6040	100	108,8	6,3
İS39	66-0100.8041	100	112,2	8,1
İS39	66-0110.6042	110	118,8	6,3
İS39	66-0110.8043	110	122,2	8,1
İS39	66-0120.6044	120	128,8	6,3
İS39	66-0120.8045	120	132,2	8,1
İS39	66-0125.6046	125	133,8	6,3
İS39	66-0125.8047	125	137,2	8,1
İS39	66-0130.6048	130	138,8	6,3
İS39	66-0130.8049	130	142,2	8,1
İS39	66-0140.6050	140	148,8	6,3
İS39	66-0140.8051	140	152,2	8,1
İS39	66-0150.8052	150	162,2	8,1
İS39	66-0150.9053	150	166	9,5
İS39	66-0160.8054	160	172,2	8,1
İS39	66-0160.9055	160	176	9,5
İS39	66-0170.8056	170	182,2	8,1
İS39	66-0170.9057	170	186	9,5
İS39	66-0180.8058	180	192,2	8,1
İS39	66-0180.9059	180	196	9,5
İS39	66-0190.8060	190	202,2	8,1
İS39	66-0190.9061	190	206	9,5
İS39	66-0200.8062	200	212,2	8,1
İS39	66-0200.9063	200	216	9,5
İS39	66-0220.8064	220	232,2	8,1
İS39	66-0220.9065	220	236	9,5

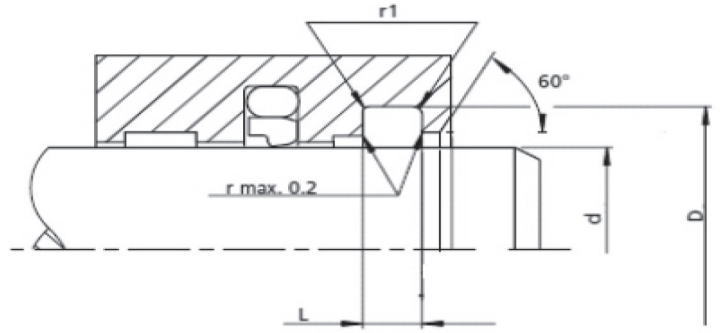
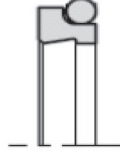
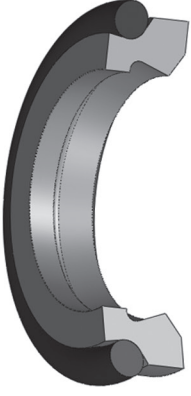

**PTFE TOZ KEÇESİ
İS39**

TİP	REF. NO	ø d	ø D	B
İS39	66-0240.8066	240	252,2	8,1
İS39	66-0240.9067	240	256	9,5
İS39	66-0250.8068	250	262,2	8,1
İS39	66-0250.9069	250	266	9,5
İS39	66-0260.0070	260	276	9,5
İS39	66-0270.0071	270	286	9,5
İS39	66-0280.0072	280	296	9,5
İS39	66-0300.0073	300	316	9,5
İS39	66-0320.0074	320	336	9,5
İS39	66-0330.0075	330	346	9,5
İS39	66-0350.0076	350	366	9,5
İS39	66-0360.0077	360	376	9,5
İS39	66-0380.0078	380	396	9,5
İS39	66-0400.9079	400	416	9,5
İS39	66-0400.0080	400	424	14
İS39	66-0420.0081	420	444	14
İS39	66-0440.0082	440	464	14
İS39	66-0450.0083	450	474	14
İS39	66-0460.0084	460	484	14
İS39	66-0480.0085	480	504	14
İS39	66-0500.0086	500	524	14

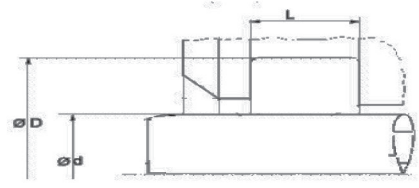
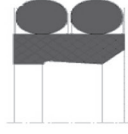

PTFE TOZ KEÇESİ İS40				
TİP	REF. NO	ø d	ø D	B
İS40	67-0020.0001	20	27,6	4,2
İS40	67-0025.0002	25	32,6	4,2
İS40	67-0028.0003	28	35,6	4,2
İS40	67-0030.0004	30	37,6	4,2
İS40	67-0032.0005	32	39,6	4,2
İS40	67-0035.0006	35	42,6	4,2
İS40	67-0036.0007	36	43,6	4,2
İS40	67-0040.0008	40	48,8	6,3
İS40	67-0042.0009	42	50,8	6,3
İS40	67-0045.0010	45	53,8	6,3
İS40	67-0050.0011	50	58,8	6,3
İS40	67-0055.0012	55	63,8	6,3
İS40	67-0056.0013	56	64,8	6,3
İS40	67-0060.0014	60	68,8	6,3
İS40	67-0063.0015	63	71,8	6,3
İS40	67-0065.0016	65	73,8	6,3
İS40	67-0070.0017	70	82,2	8,1
İS40	67-0075.0018	75	87,2	8,1
İS40	67-0080.0019	80	92,2	8,1
İS40	67-0085.0020	85	97,2	8,1
İS40	67-0090.0021	90	102,2	8,1
İS40	67-0100.0022	100	112,2	8,1
İS40	67-0110.0023	110	122,2	8,1
İS40	67-0115.0024	115	127,2	8,1
İS40	67-0120.0025	120	132,2	8,1
İS40	67-0125.0026	125	137,2	8,1
İS40	67-0130.0027	130	142,2	8,1
İS40	67-0140.0028	140	156	11,5
İS40	67-0150.0029	150	166	11,5
İS40	67-0160.0030	160	176	11,5
İS40	67-0170.0031	170	186	11,5
İS40	67-0180.0032	180	196	11,5
İS40	67-0190.0033	190	206	11,5

PTFE TOZ KEÇESİ İS40				
TİP	REF. NO	ø d	ø D	B
İS40	67-0200.0034	200	216	11,5
İS40	67-0210.0035	210	226	11,5
İS40	67-0220.0036	220	236	11,5
İS40	67-0230.0037	230	246	11,5
İS40	67-0240.0038	240	256	11,5
İS40	67-0250.0039	250	266	11,5
İS40	67-0260.0040	260	276	11,5
İS40	67-0270.0041	270	286	11,5
İS40	67-0280.0042	280	296	11,5
İS40	67-0290.0043	290	306	11,5
İS40	67-0300.0044	300	316	11,5
İS40	67-0300.0045	310	326	11,5
İS40	67-0300.0046	320	336	11,5
İS40	67-0300.0047	330	346	11,5
İS40	67-0300.0048	340	356	11,5
İS40	67-0300.0049	350	366	11,5
İS40	67-0300.0050	360	376	11,5
İS40	67-0300.0051	370	386	11,5
İS40	67-0300.0052	380	396	11,5
İS40	67-0300.0053	390	406	11,5
İS40	67-0400.0054	400	416	11,5



EPDM / NBR ŞERİT O-RİNG İS110		
TİP	REF. NO	ÖLÇÜ
İS110	55-0000.0001	Q2 mm
İS110	55-0000.0002	Q2,5 mm
İS110	55-0000.0003	Q3 mm
İS110	55-0000.0004	Q3,5 mm
İS110	55-0000.0005	Q4 mm
İS110	55-0000.0006	Q4,5 mm
İS110	55-0000.0006	Q5 mm
İS110	55-0000.0007	Q5,5 mm
İS110	55-0000.0008	Q6 mm
İS110	55-0000.0009	Q6,5 mm
İS110	55-0000.0010	Q7 mm
İS110	55-0000.0011	Q7,5 mm
İS110	55-0000.0012	Q8 mm
İS110	55-0000.0013	Q8,5 mm
İS110	55-0000.0014	Q9 mm
İS110	55-0000.0015	Q10 mm
İS110	55-0000.0016	Q11 mm
İS110	55-0000.0017	Q12 mm
İS110	55-0000.0018	Q13 mm
İS110	55-0000.0019	Q14 mm
İS110	55-0000.0020	Q15 mm
İS110	55-0000.0021	Q16 mm
İS110	55-0000.0022	Q17 mm
İS110	55-0000.0023	Q18 mm
İS110	55-0000.0024	Q19 mm
İS110	55-0000.0025	Q20 mm
İS110	55-0000.0026	Q21 mm
İS110	55-0000.0027	Q22 mm
İS110	55-0000.0028	Q23 mm
İS110	55-0000.0029	Q24 mm
İS110	55-0000.0030	Q25 mm
İS110	55-0000.0031	Q30 mm
İS110	55-0000.0032	Q35 mm

EPDM / NBR ŞERİT O-RİNG İS110		
TİP	REF. NO	ÖLÇÜ
İS110	55-0000.0033	Q40 mm
İS110	55-0000.0034	Q45 mm
İS110	55-0000.0035	Q50 mm



SİLİKON ŞERİT O-RİNG İS110		
TİP	REF. NO	ÖLÇÜ
İS110	56-0000.0001	Q1 mm
İS110	56-0000.0002	Q2 mm
İS110	56-0000.0003	Q3 mm
İS110	56-0000.0004	Q4 mm
İS110	56-0000.0005	Q5 mm
İS110	56-0000.0006	Q6 mm
İS110	56-0000.0007	Q7 mm
İS110	56-0000.0008	Q8 mm
İS110	56-0000.0009	Q9 mm
İS110	56-0000.0010	Q10 mm
İS110	56-0000.0011	Q11 mm
İS110	56-0000.0012	Q12 mm
İS110	56-0000.0013	Q13 mm
İS110	56-0000.0014	Q14 mm
İS110	56-0000.0015	Q15 mm
İS110	56-0000.0016	Q16 mm



SİLİKON-NBR-FKM ŞERİT O-RİNG İTHAL İS110		
TİP	REF. NO	ÖLÇÜ
İS110	57-0000.0015	Q1,50 mm
İS110	57-0000.0178	Q1,78 mm
İS110	57-0000.0002	Q2,00 mm
İS110	57-0000.0025	Q2,50 mm
İS110	57-0000.0003	Q3,00 mm
İS110	57-0000.0035	Q3,50 mm
İS110	57-0000.0004	Q4,00 mm
İS110	57-0000.0045	Q4,50 mm
İS110	57-0000.0005	Q5,00 mm
İS110	57-0000.0055	Q5,50 mm
İS110	57-0000.0006	Q6,00 mm
İS110	57-0000.0007	Q7,00 mm
İS110	57-0000.0008	Q8,00 mm
İS110	57-0000.0009	Q9,00 mm
İS110	57-0000.0010	Q10,0 mm

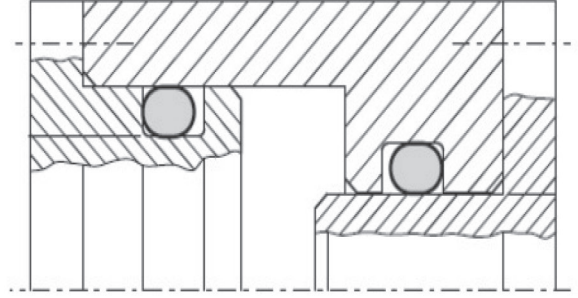
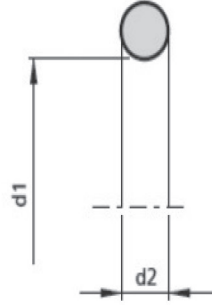

O-RİNG İSO		
TİP	REF. NO	ÖLÇÜ
		$\emptyset d_1 \times \emptyset d_2$
O-RİNG	60-0000.0182	2,00X2,00
O-RİNG	60-0000.0232	3,00X2,00
O-RİNG	60-0000.0098	5,00X1,60
O-RİNG	60-0000.0101	5,00X2,00
O-RİNG	60-0000.0568	5,00X2,40
O-RİNG	60-0000.0613	6,00X1,00
O-RİNG	60-0000.0506	6,00X2,00
O-RİNG	60-0000.0097	6,00X5,00
O-RİNG	60-0000.0023	6,20X4,50
O-RİNG	60-0000.0067	6,30X2,30
O-RİNG	60-0000.0510	6,50X2,00
O-RİNG	60-0000.0179	7,00X1,60
O-RİNG	60-0000.0174	7,00X1,80
O-RİNG	60-0000.0532	7,50X2,50
O-RİNG	60-0000.0507	9,25X1,78
O-RİNG	60-0000.0374	10,00X2,50
O-RİNG	60-0000.0156	10,00X4,50
O-RİNG	60-0000.0260	10,00X6,00
O-RİNG	60-0000.0563	10,82X1,78
O-RİNG	60-0000.0505	11,00X2,00
O-RİNG	60-0000.0178	11,00X4,00
O-RİNG	60-0000.0131	11,00X6,00
O-RİNG	60-0000.0252	11,00X7,00
O-RİNG	60-0000.0256	11,90X2,62
O-RİNG	60-0000.0027	12,00X2,00
O-RİNG	60-0000.0032	12,00X3,00
O-RİNG	60-0000.0254	12,00X10,00
O-RİNG	60-0000.0029	12,30X7,00
O-RİNG	60-0000.0027	12,37X2,62
O-RİNG	60-0000.0054	12,70X4,40
O-RİNG	60-0000.0422	13,00X2,50
O-RİNG	60-0000.0069	13,00X3,00
O-RİNG	60-0000.0503	13,45X2,62

O-RİNG İSO		
TİP	REF. NO	ÖLÇÜ
		$\emptyset d_1 \times \emptyset d_2$
O-RİNG	60-0000.0178	13,50X2,50
O-RİNG	60-0000.0138	14,00X2,00
O-RİNG	60-0000.0511	14,00X3,00
O-RİNG	60-0000.0339	14,10X2,62
O-RİNG	60-0000.0421	15,00X2,62
O-RİNG	60-0000.0078	15,00X3,00
O-RİNG	60-0000.0547	15,00X3,20
O-RİNG	60-0000.0002	15,25X4,35
O-RİNG	60-0000.0008	15,34X4,53
O-RİNG	60-0000.0127	15,50X3,50
O-RİNG	60-0000.0305	15,88X2,62
O-RİNG	60-0000.0382	16,00X1,50
O-RİNG	60-0000.0504	16,00X2,00
O-RİNG	60-0000.0231	16,00X3,00
O-RİNG	60-0000.0167	16,20X2,20
O-RİNG	60-0000.0082	16,50X6,00
O-RİNG	60-0000.0531	17,00X2,50
O-RİNG	60-0000.0634	17,00X4,00
O-RİNG	60-0000.0576	17,00X5,00
O-RİNG	60-0000.0562	17,12X2,62
O-RİNG	60-0000.0345	17,50X3,00
O-RİNG	60-0000.0237	18,00X2,00
O-RİNG	60-0000.0642	18,00X2,50
O-RİNG	60-0000.0048	18,00X4,00
O-RİNG	60-0000.0112	18,00X7,00
O-RİNG	60-0000.0039	18,00X8,00
O-RİNG	60-0000.0068	18,50X4,80
O-RİNG	60-0000.0514	18,64X3,53
O-RİNG	60-0000.0230	18,72X2,62
O-RİNG	60-0000.0180	19,00X2,50
O-RİNG	60-0000.0030	19,00X3,00
O-RİNG	60-0000.0070	19,00X6,00
O-RİNG	60-0000.0792	19,05X3,17

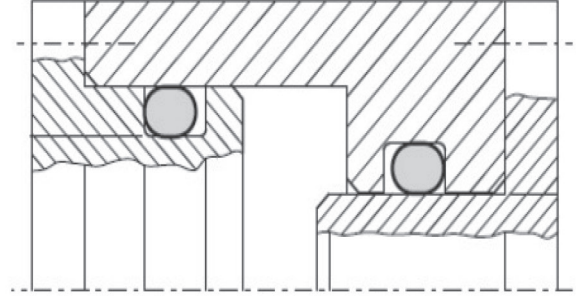
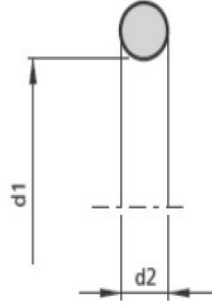

O-RİNG İSO		
TİP	REF. NO	ÖLÇÜ
		$\emptyset d_1 \times \emptyset d_2$
O-RİNG	60-0000.0608	19,45X2,62
O-RİNG	60-0000.0107	19,50X3,00
O-RİNG	60-0000.0391	19,50X6,00
O-RİNG	60-0000.0141	19,60X3,50
O-RİNG	60-0000.0170	20,00X1,00
O-RİNG	60-0000.0288	20,00X2,50
O-RİNG	60-0000.0199	20,00X3,00
O-RİNG	60-0000.0313	20,00X3,50
O-RİNG	60-0000.0423	20,00X4,00
O-RİNG	60-0000.0377	20,00X4,20
O-RİNG	60-0000.0299	20,00X5,00
O-RİNG	60-0000.0273	20,00X6,00
O-RİNG	60-0000.0164	20,00X6,50
O-RİNG	60-0000.0007	20,00X8,00
O-RİNG	60-0000.0141	20,80X3,50
O-RİNG	60-0000.0162	21,50X2,50
O-RİNG	60-0000.0187	21,80X3,50
O-RİNG	60-0000.0402	22,00X1,00
O-RİNG	60-0000.0557	22,00X2,00
O-RİNG	60-0000.0575	22,00X2,50
O-RİNG	60-0000.0564	22,00X4,00
O-RİNG	60-0000.0116	23,00X3,00
O-RİNG	60-0000.0607	23,00X4,00
O-RİNG	60-0000.0285	23,46X2,94
O-RİNG	60-0000.0567	23,46X3,53
O-RİNG	60-0000.0185	23,50X2,90
O-RİNG	60-0000.0612	23,98X1,78
O-RİNG	60-0000.0143	24,00X2,50
O-RİNG	60-0000.0497	24,00X3,00
O-RİNG	60-0000.0313	24,00X3,50
O-RİNG	60-0000.0402	25,00X1,00
O-RİNG	60-0000.0591	25,00X2,50
O-RİNG	60-0000.0133	25,00X3,00

O-RİNG İSO		
TİP	REF. NO	ÖLÇÜ
		$\emptyset d_1 \times \emptyset d_2$
O-RİNG	60-0000.0161	25,00X3,50
O-RİNG	60-0000.0083	25,00X5,00
O-RİNG	60-0000.0421	25,00X6,00
O-RİNG	60-0000.0302	25,00X7,00
O-RİNG	60-0000.0426	25,00X8,00
O-RİNG	60-0000.0205	25,80X3,00
O-RİNG	60-0000.0634	26,40X4,00
O-RİNG	60-0000.0403	27,00X1,00
O-RİNG	60-0000.0079	27,00X2,50
O-RİNG	60-0000.0287	27,00X3,00
O-RİNG	60-0000.0639	27,00X3,50
O-RİNG	60-0000.0372	27,00X4,00
O-RİNG	60-0000.0304	27,50X2,70
O-RİNG	60-0000.0287	28,00X3,00
O-RİNG	60-0000.0138	28,00X3,50
O-RİNG	60-0000.0047	28,00X4,00
O-RİNG	60-0000.0536	28,00X5,00
O-RİNG	60-0000.0783	28,00X8,00
O-RİNG	60-0000.0064	28,60X3,53
O-RİNG	60-0000.0266	28,80X7,30
O-RİNG	60-0000.0566	29,34X2,62
O-RİNG	60-0000.0289	29,50X3,00
O-RİNG	60-0000.0403	30,00X1,00
O-RİNG	60-0000.0401	30,00X1,50
O-RİNG	60-0000.0031	30,00X3,00
O-RİNG	60-0000.0308	30,00X3,50
O-RİNG	60-0000.0172	30,00X4,00
O-RİNG	60-0000.0336	30,00X5,00
O-RİNG	60-0000.0093	30,00X6,00
O-RİNG	60-0000.0099	30,00X8,00
O-RİNG	60-0000.0406	30,00X15,00
O-RİNG	60-0000.0556	31,00X2,80
O-RİNG	60-0000.0336	31,00X3,50

O-RİNG İSO		
TİP	REF. NO	ÖLÇÜ
		$\emptyset d_1 \times \emptyset d_2$
O-RİNG	60-0000.0290	31,00X5,00
O-RİNG	60-0000.0556	31,30X2,80
O-RİNG	60-0000.0395	31,34X3,50
O-RİNG	60-0000.0344	31,42X2,62
O-RİNG	60-0000.0375	31,50X3,00
O-RİNG	60-0000.0401	32,00X1,50
O-RİNG	60-0000.0143	32,00X2,20
O-RİNG	60-0000.0593	32,00X3,00
O-RİNG	60-0000.0199	32,00X3,50
O-RİNG	60-0000.0208	32,00X4,00
O-RİNG	60-0000.0192	32,00X8,00
O-RİNG	60-0000.0647	32,20X3,20
O-RİNG	60-0000.0059	32,50X5,35
O-RİNG	60-0000.0404	32,00X1,00
O-RİNG	60-0000.0793	33,00X1,20
O-RİNG	60-0000.0399	33,00X1,50
O-RİNG	60-0000.0161	33,00X3,50
O-RİNG	60-0000.0258	33,00X5,00
O-RİNG	60-0000.0038	33,00X6,00
O-RİNG	60-0000.0592	34,00X3,00
O-RİNG	60-0000.0045	34,00X3,50
O-RİNG	60-0000.0103	34,00X4,00
O-RİNG	60-0000.0784	34,00X8,00
O-RİNG	60-0000.0646	34,20X3,20
O-RİNG	60-0000.0066	34,20X4,76
O-RİNG	60-0000.0530	34,50X4,50
O-RİNG	60-0000.0400	35,00X1,00
O-RİNG	60-0000.0296	35,00X2,50
O-RİNG	60-0000.0152	35,00X3,00
O-RİNG	60-0000.0569	35,00X3,20
O-RİNG	60-0000.0606	35,00X3,30
O-RİNG	60-0000.0158	35,00X3,50
O-RİNG	60-0000.0173	35,00X4,00
O-RİNG	60-0000.0601	35,00X4,30
O-RİNG	60-0000.0075	35,00X4,50
O-RİNG	60-0000.0060	35,00X6,00
O-RİNG	60-0000.0340	36,00X1,00
O-RİNG	60-0000.0351	36,00X1,50
O-RİNG	60-0000.0788	36,10X2,62
O-RİNG	60-0000.0286	36,00X3,00
O-RİNG	60-0000.0168	36,00X4,00
O-RİNG	60-0000.0251	36,00X5,90
O-RİNG	60-0000.0144	36,00X6,00
O-RİNG	60-0000.0257	36,00X6,50

O-RİNG İSO		
TİP	REF. NO	ÖLÇÜ
		$\emptyset d_1 \times \emptyset d_2$
O-RİNG	60-0000.0338	36,10X2,62
O-RİNG	60-0000.0646	36,20X3,20
O-RİNG	60-0000.0158	37,00X3,50
O-RİNG	60-0000.0124	37,00X5,00
O-RİNG	60-0000.0394	37,47X5,33
O-RİNG	60-0000.0789	37,50X3,50
O-RİNG	60-0000.0337	37,75X2,62
O-RİNG	60-0000.0400	38,00X1,00
O-RİNG	60-0000.0399	38,00X1,50
O-RİNG	60-0000.0286	38,00X3,00
O-RİNG	60-0000.0236	38,00X3,50
O-RİNG	60-0000.0209	38,00X4,00
O-RİNG	60-0000.0534	38,00X4,50
O-RİNG	60-0000.0006	38,00X6,00
O-RİNG	60-0000.0015	38,10X3,17
O-RİNG	60-0000.0533	38,40X5,33
O-RİNG	60-0000.0591	39,00X3,00
O-RİNG	60-0000.0289	39,34X2,62
O-RİNG	60-0000.0496	39,69X3,53
O-RİNG	60-0000.0303	40,00X2,00
O-RİNG	60-0000.0324	40,00X2,50
O-RİNG	60-0000.0030	40,00X3,00
O-RİNG	60-0000.0050	40,00X3,75
O-RİNG	60-0000.0171	40,00X4,00
O-RİNG	60-0000.0559	40,00X5,00
O-RİNG	60-0000.0779	40,64X5,33
O-RİNG	60-0000.0509	40,00X6,00
O-RİNG	60-0000.0177	40,00X6,50
O-RİNG	60-0000.0636	40,00X7,00
O-RİNG	60-0000.0407	40,00X7,50
O-RİNG	60-0000.0134	41,00X3,50
O-RİNG	60-0000.0136	41,00X4,00
O-RİNG	60-0000.0597	42,00X3,00
O-RİNG	60-0000.0647	42,20X3,20
O-RİNG	60-0000.0160	42,00X3,50
O-RİNG	60-0000.0643	42,00X3,80
O-RİNG	60-0000.0026	42,00X8,70
O-RİNG	60-0000.0376	43,00X3,00
O-RİNG	60-0000.0248	43,00X4,00
O-RİNG	60-0000.0106	43,75X2,50
O-RİNG	60-0000.0176	44,00X2,00
O-RİNG	60-0000.0555	44,00X4,00
O-RİNG	60-0000.0160	44,00X4,50
O-RİNG	60-0000.0508	44,00X5,00

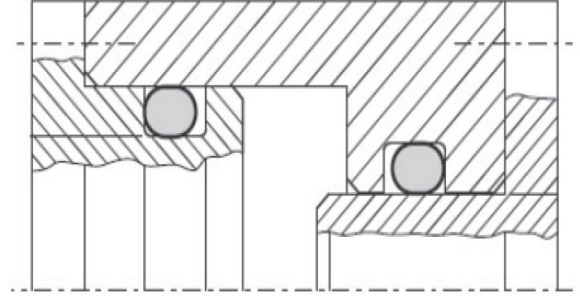
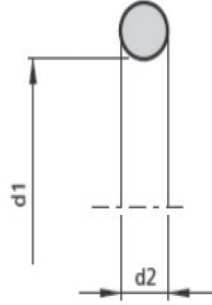

O-RİNG İSO		
TİP	REF. NO	ÖLÇÜ
		$\emptyset d_1 \times \emptyset d_2$
O-RİNG	60-0000.0573	44,00X8,00
O-RİNG	60-0000.0599	44,20X2,50
O-RİNG	60-0000.0152	45,00X3,00
O-RİNG	60-0000.0157	45,00X3,50
O-RİNG	60-0000.0373	45,00X4,00
O-RİNG	60-0000.0004	45,00X10,00
O-RİNG	60-0000.0610	46,00X3,00
O-RİNG	60-0000.0040	46,00X4,50
O-RİNG	60-0000.0115	47,00X1,80
O-RİNG	60-0000.0381	47,00X3,53
O-RİNG	60-0000.0396	47,00X5,00
O-RİNG	60-0000.0277	47,00X5,34
O-RİNG	60-0000.0574	47,30X2,60
O-RİNG	60-0000.0776	47,00X8,00
O-RİNG	60-0000.0159	48,00X3,00
O-RİNG	60-0000.0271	48,00X4,00
O-RİNG	60-0000.0065	48,00X4,76
O-RİNG	60-0000.0148	48,00X5,00
O-RİNG	60-0000.0369	48,00X6,00
O-RİNG	60-0000.0791	49,15X8,00
O-RİNG	60-0000.0653	49,21X3,53
O-RİNG	60-0000.0598	49,70X5,70
O-RİNG	60-0000.0611	50,00X2,00
O-RİNG	60-0000.0207	50,00X2,60
O-RİNG	60-0000.0154	50,00X3,00
O-RİNG	60-0000.0165	50,00X3,50
O-RİNG	60-0000.0096	50,00X4,00
O-RİNG	60-0000.0166	50,00X4,50
O-RİNG	60-0000.0166	50,00X5,00
O-RİNG	60-0000.0385	50,00X5,20
O-RİNG	60-0000.0130	50,00X5,70
O-RİNG	60-0000.0352	50,00X6,00
O-RİNG	60-0000.0398	50,00X6,50

O-RİNG İSO		
TİP	REF. NO	ÖLÇÜ
		$\emptyset d_1 \times \emptyset d_2$
O-RİNG	60-0000.0332	50,00X7,00
O-RİNG	60-0000.0604	50,00X16,00
O-RİNG	60-0000.0393	50,16X5,33
O-RİNG	60-0000.0271	50,30X5,50
O-RİNG	60-0000.0129	51,00X3,50
O-RİNG	60-0000.0053	51,00X3,75
O-RİNG	60-0000.0077	52,00X4,75
O-RİNG	60-0000.0513	52,00X5,00
O-RİNG	60-0000.0046	52,00X7,00
O-RİNG	60-0000.0142	53,00X5,00
O-RİNG	60-0000.0424	53,34X5,33
O-RİNG	60-0000.0529	53,57X3,53
O-RİNG	60-0000.0129	54,00X3,00
O-RİNG	60-0000.0147	54,00X3,50
O-RİNG	60-0000.0390	54,00X4,00
O-RİNG	60-0000.0776	54,00X8,00
O-RİNG	60-0000.0155	55,00X3,00
O-RİNG	60-0000.0247	55,00X5,00
O-RİNG	60-0000.0554	55,00X6,00
O-RİNG	60-0000.0365	56,00X3,00
O-RİNG	60-0000.0303	56,00X3,50
O-RİNG	60-0000.0091	56,00X4,00
O-RİNG	60-0000.0495	56,00X6,00
O-RİNG	60-0000.0570	56,52X5,33
O-RİNG	60-0000.0090	57,00X3,00
O-RİNG	60-0000.0253	57,00X3,40
O-RİNG	60-0000.0210	57,50X3,50
O-RİNG	60-0000.0396	59,00X5,34
O-RİNG	60-0000.0145	59,00X6,80
O-RİNG	60-0000.0387	59,92X3,50
O-RİNG	60-0000.0206	60,00X3,20
O-RİNG	60-0000.0626	60,00X3,60
O-RİNG	60-0000.0595	60,00X4,00

O-RİNG İSO		
TİP	REF. NO	ÖLÇÜ
		$\varnothing d_1 \times \varnothing d_2$
O-RİNG	60-0000.0371	60,00X4,50
O-RİNG	60-0000.0153	60,00X5,00
O-RİNG	60-0000.0306	60,00X5,34
O-RİNG	60-0000.0163	60,00X6,10
O-RİNG	60-0000.0425	60,00X6,50
O-RİNG	60-0000.0298	62,00X2,62
O-RİNG	60-0000.0778	62,00X4,00
O-RİNG	60-0000.0113	62,00X8,00
O-RİNG	60-0000.0628	62,00X11,0
O-RİNG	60-0000.0333	62,50X5,00
O-RİNG	60-0000.0132	63,00X2,00
O-RİNG	60-0000.0094	63,50X3,50
O-RİNG	60-0000.0297	64,00X3,00
O-RİNG	60-0000.0545	64,00X5,33
O-RİNG	60-0000.0527	64,00X6,00
O-RİNG	60-0000.0614	64,00X7,00
O-RİNG	60-0000.0492	64,00X8,00
O-RİNG	60-0000.0259	65,00X2,50
O-RİNG	60-0000.0596	65,00X3,00
O-RİNG	60-0000.0618	65,00X3,50
O-RİNG	60-0000.0259	65,00X4,00
O-RİNG	60-0000.0150	65,00X4,50
O-RİNG	60-0000.0279	65,00X5,00
O-RİNG	60-0000.0552	65,00X5,33
O-RİNG	60-0000.0334	65,00X5,50
O-RİNG	60-0000.0528	65,00X5,70
O-RİNG	60-0000.0240	65,00X6,10
O-RİNG	60-0000.0493	65,00X8,00
O-RİNG	60-0000.0317	65,90X7,00
O-RİNG	60-0000.0605	66,00X3,00
O-RİNG	60-0000.0135	66,50X1,80
O-RİNG	60-0000.0122	67,00X2,00
O-RİNG	60-0000.0553	67,00X3,00
O-RİNG	60-0000.0035	67,00X6,00
O-RİNG	60-0000.0041	67,00X6,50
O-RİNG	60-0000.0370	67,00X13,00
O-RİNG	60-0000.0491	68,00X3,00
O-RİNG	60-0000.0565	68,00X3,50
O-RİNG	60-0000.0543	68,00X5,00
O-RİNG	60-0000.0207	70,00X2,60
O-RİNG	60-0000.0397	70,00X3,00
O-RİNG	60-0000.0626	70,00X3,60
O-RİNG	60-0000.0235	70,00X4,00
O-RİNG	60-0000.0128	70,00X5,00

O-RİNG İSO		
TİP	REF. NO	ÖLÇÜ
		$\varnothing d_1 \times \varnothing d_2$
O-RİNG	60-0000.0128	70,00X5,50
O-RİNG	60-0000.0780	70,00X5,70
O-RİNG	60-0000.0137	70,00X6,00
O-RİNG	60-0000.0025	70,00X8,00
O-RİNG	60-0000.0239	70,00X10,00
O-RİNG	60-0000.0210	70,50X3,80
O-RİNG	60-0000.0017	71,00X7,00
O-RİNG	60-0000.0332	71,00X5,60
O-RİNG	60-0000.0149	72,00X4,00
O-RİNG	60-0000.0044	72,00X5,50
O-RİNG	60-0000.0603	72,00X10,00
O-RİNG	60-0000.0521	72,50X4,00
O-RİNG	60-0000.0571	72,60X3,53
O-RİNG	60-0000.0090	73,00X3,00
O-RİNG	60-0000.0217	73,00X4,00
O-RİNG	60-0000.0495	73,00X6,00
O-RİNG	60-0000.0335	73,50X5,34
O-RİNG	60-0000.0111	74,00X3,00
O-RİNG	60-0000.0003	74,00X10,00
O-RİNG	60-0000.0324	75,00X3,50
O-RİNG	60-0000.0572	75,00X4,00
O-RİNG	60-0000.0196	75,00X5,00
O-RİNG	60-0000.0196	75,00X6,00
O-RİNG	60-0000.0125	75,00X6,50
O-RİNG	60-0000.0020	75,00X10,00
O-RİNG	60-0000.0577	75,57X5,33
O-RİNG	60-0000.0516	76,00X6,00
O-RİNG	60-0000.0521	75,79X3,53
O-RİNG	60-0000.0272	76,20X3,50
O-RİNG	60-0000.0246	76,50X5,00
O-RİNG	60-0000.0175	78,00X2,40
O-RİNG	60-0000.0369	78,00X3,00
O-RİNG	60-0000.0535	78,00X7,00
O-RİNG	60-0000.0363	78,00X9,00
O-RİNG	60-0000.0365	78,50X3,00
O-RİNG	60-0000.0265	79,00X3,50
O-RİNG	60-0000.0512	79,77X5,33
O-RİNG	60-0000.0378	80,00X2,00
O-RİNG	60-0000.0204	80,00X3,00
O-RİNG	60-0000.0195	80,00X5,00
O-RİNG	60-0000.0195	80,00X6,00
O-RİNG	60-0000.0366	80,00X8,00
O-RİNG	60-0000Ç0798	81,00X4,50
O-RİNG	60-0000.0602	82,00X4,00

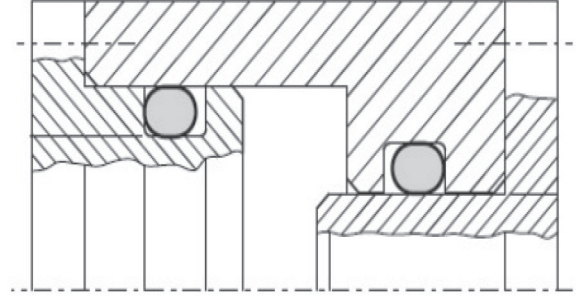
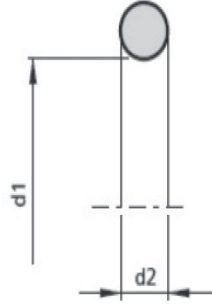

O-RİNG İSO		
TİP	REF. NO	ÖLÇÜ
		$\emptyset d_1 \times \emptyset d_2$
O-RİNG	60-0000.0297	84,00X3,00
O-RİNG	60-0000.0216	85,00X3,00
O-RİNG	60-0000.0296	85,00X3,50
O-RİNG	60-0000.0367	85,00X4,00
O-RİNG	60-0000.0194	85,00X5,00
O-RİNG	60-0000.0644	85,00X5,50
O-RİNG	60-0000.0194	85,00X6,00
O-RİNG	60-0000.0368	85,00X6,50
O-RİNG	60-0000.0043	85,00X7,00
O-RİNG	60-0000.0080	85,50X4,00
O-RİNG	60-0000.0620	86,00X3,00
O-RİNG	60-0000.0550	86,00X5,00
O-RİNG	60-0000.0645	86,50X5,33
O-RİNG	60-0000.0543	87,00X5,00
O-RİNG	60-0000.0021	87,00X9,20
O-RİNG	60-0000.0210	88,00X3,50
O-RİNG	60-0000.0546	88,00X5,70
O-RİNG	60-0000.0310	88,50X5,34
O-RİNG	60-0000.0494	89,69X5,34
O-RİNG	60-0000.0389	90,00X2,50
O-RİNG	60-0000.0235	90,00X3,00
O-RİNG	60-0000.0500	90,00X4,00
O-RİNG	60-0000.0193	90,00X5,00
O-RİNG	60-0000.0323	90,00X5,34
O-RİNG	60-0000.0649	90,00X5,70
O-RİNG	60-0000.0189	90,00X6,00
O-RİNG	60-0000.0278	90,00X7,00
O-RİNG	60-0000.0362	90,00X20,00
O-RİNG	60-0000.0517	91,44X5,33
O-RİNG	60-0000.0498	91,67X3,53
O-RİNG	60-0000.0495	92,00X4,00
O-RİNG	60-0000.0049	92,00X5,50
O-RİNG	60-0000.0342	93,00X4,00

O-RİNG İSO		
TİP	REF. NO	ÖLÇÜ
		$\emptyset d_1 \times \emptyset d_2$
O-RİNG	60-0000Ç0797	93,00X8,00
O-RİNG	60-0000.0033	93,00X8,20
O-RİNG	60-0000.0090	94,00X3,00
O-RİNG	60-0000.0085	94,00X8,00
O-RİNG	60-0000.0214	95,00X5,00
O-RİNG	60-0000.0042	95,00X7,50
O-RİNG	60-0000.0183	95,00X10,00
O-RİNG	60-0000.0315	96,00X2,30
O-RİNG	60-0000.0307	96,20X5,80
O-RİNG	60-0000.0084	97,00X2,20
O-RİNG	60-0000.0359	97,00X5,50
O-RİNG	60-0000.0551	97,80X5,33
O-RİNG	60-0000.0063	98,00X3,10
O-RİNG	60-0000.0090	98,70X7,00
O-RİNG	60-0000.0087	99,00X3,10
O-RİNG	60-0000.0320	99,60X5,70
O-RİNG	60-0000.0210	57,50X3,50
O-RİNG	60-0000.0396	59,00X5,34
O-RİNG	60-0000.0145	59,00X6,80
O-RİNG	60-0000.0387	59,92X3,50
O-RİNG	60-0000.0206	60,00X3,20
O-RİNG	60-0000.0626	60,00X3,60
O-RİNG	60-0000.0595	60,00X4,00
O-RİNG	60-0000.0371	60,00X4,50
O-RİNG	60-0000.0153	60,00X5,00
O-RİNG	60-0000.0306	60,00X5,34
O-RİNG	60-0000.0163	60,00X6,10
O-RİNG	60-0000.0425	60,00X6,50
O-RİNG	60-0000.0298	62,00X2,62
O-RİNG	60-0000.0113	62,00X8,00
O-RİNG	60-0000.0628	62,00X11,0
O-RİNG	60-0000.0333	62,50X5,00
O-RİNG	60-0000.0132	63,00X2,00

O-RİNG İSO		
TİP	REF. NO	ÖLÇÜ
		$\emptyset d_1 \times \emptyset d_2$
O-RİNG	60-0000.0094	63,50X3,50
O-RİNG	60-0000.0297	64,00X3,00
O-RİNG	60-0000.0545	64,00X5,33
O-RİNG	60-0000.0527	64,00X6,00
O-RİNG	60-0000.0614	64,00X7,00
O-RİNG	60-0000.0492	64,00X8,00
O-RİNG	60-0000.0259	65,00X2,50
O-RİNG	60-0000.0596	65,00X3,00
O-RİNG	60-0000.0618	65,00X3,50
O-RİNG	60-0000.0259	65,00X4,00
O-RİNG	60-0000.0150	65,00X4,50
O-RİNG	60-0000.0279	65,00X5,00
O-RİNG	60-0000.0552	65,00X5,33
O-RİNG	60-0000.0334	65,00X5,50
O-RİNG	60-0000.0528	65,00X5,70
O-RİNG	60-0000.0240	65,00X6,10
O-RİNG	60-0000.0493	65,00X8,00
O-RİNG	60-0000.0589	100,00X3,00
O-RİNG	60-0000.0590	100,00X4,00
O-RİNG	60-0000.0218	100,00X4,50
O-RİNG	60-0000.0291	100,00X5,00
O-RİNG	60-0000.0211	100,00X6,00
O-RİNG	60-0000.0516	100,97X5,33
O-RİNG	60-0000.0405	101,19X3,53
O-RİNG	60-0000.0058	102,00X4,30
O-RİNG	60-0000.0616	103,00X6,00
O-RİNG	60-0000.0796	104,14X5,33
O-RİNG	60-0000.0541	104,15X7,00
O-RİNG	60-0000.0342	105,00X3,50
O-RİNG	60-0000.0056	105,00X5,50
O-RİNG	60-0000.0567	108,00X3,00
O-RİNG	60-0000.0275	108,00X4,00
O-RİNG	60-0000.0648	108,00X4,50
O-RİNG	60-0000.0263	108,00X5,00
O-RİNG	60-0000.0619	108,00X6,00
O-RİNG	60-0000.0238	109,00X8,00
O-RİNG	60-0000.0331	109,00X9,50
O-RİNG	60-0000.0410	109,50X5,34
O-RİNG	60-0000.0198	110,00X3,00
O-RİNG	60-0000.0120	110,00X3,60
O-RİNG	60-0000.0117	110,00X4,40
O-RİNG	60-0000.0001	110,00X5,00
O-RİNG	60-0000.0320	110,00X6,00
O-RİNG	60-0000.0549	112,00X5,33

O-RİNG İSO		
TİP	REF. NO	ÖLÇÜ
		$\emptyset d_1 \times \emptyset d_2$
O-RİNG	60-0000.0009	112,00X13,50
O-RİNG	60-0000.0276	113,00X7,00
O-RİNG	60-0000.0408	113,00X8,00
O-RİNG	60-0000.0140	113,70X8,60
O-RİNG	60-0000.0109	113,80X5,34
O-RİNG	60-0000.0526	113,89X3,53
O-RİNG	60-0000.0386	114,00X10,50
O-RİNG	60-0000.0409	115,00X3,00
O-RİNG	60-0000.0123	115,00X3,60
O-RİNG	60-0000.0490	115,00X4,00
O-RİNG	60-0000.0057	115,00X4,30
O-RİNG	60-0000.0214	115,00X5,00
O-RİNG	60-0000.0326	115,00X5,70
O-RİNG	60-0000.0188	115,00X6,00
O-RİNG	60-0000.0387	117,00X3,50
O-RİNG	60-0000.0525	117,50X5,34
O-RİNG	60-0000.0323	118,00X3,00
O-RİNG	60-0000.0105	118,00X5,00
O-RİNG	60-0000.0588	119,00X9,00
O-RİNG	60-0000.0411	120,00X6,00
O-RİNG	60-0000.0146	120,00X7,00
O-RİNG	60-0000.0364	120,00X10,00
O-RİNG	60-0000.0250	121,00X3,00
O-RİNG	60-0000.0346	121,00X4,00
O-RİNG	60-0000.0151	123,00X4,00
O-RİNG	60-0000.0796	123,19X3,53
O-RİNG	60-0000.0061	124,00X2,00
O-RİNG	60-0000.0414	124,70X7,00
O-RİNG	60-0000.0211	125,00X3,00
O-RİNG	60-0000.0637	125,00X3,50
O-RİNG	60-0000.0028	125,00X4,50
O-RİNG	60-0000.0062	125,00X5,00
O-RİNG	60-0000.0221	125,00X6,80
O-RİNG	60-0000.0774	125,00X8,00
O-RİNG	60-0000.0071	126,00X14,00
O-RİNG	60-0000.0361	128,00X3,50
O-RİNG	60-0000.0330	128,00X9,00
O-RİNG	60-0000.03635	129,00X9,50
O-RİNG	60-0000.0637	130,00X2,62
O-RİNG	60-0000.0227	130,00X3,00
O-RİNG	60-0000.0233	130,00X4,00
O-RİNG	60-0000.0114	130,00X7,00
O-RİNG	60-0000.0190	130,00X14,00
O-RİNG	60-0000.0518	132,77X5,33

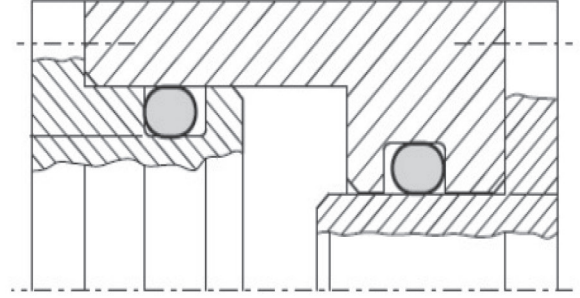
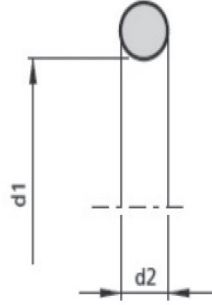

O-RİNG İSO		
TİP	REF. NO	ÖLÇÜ
		$\emptyset d_1 \times \emptyset d_2$
O-RİNG	60-0000.0322	133,00X3,50
O-RİNG	60-0000.0119	134,00X3,00
O-RİNG	60-0000.0126	135,00X1,50
O-RİNG	60-0000.0300	135,00X4,00
O-RİNG	60-0000.0189	135,00X6,00
O-RİNG	60-0000.0118	135,00X6,50
O-RİNG	60-0000.0516	135,50X5,33
O-RİNG	60-0000.0280	139,00X3,50
O-RİNG	60-0000.0781	139,00X7,00
O-RİNG	60-0000.0267	139,50X7,50
O-RİNG	60-0000.0241	140,00X2,62
O-RİNG	60-0000.0110	140,00X3,00
O-RİNG	60-0000.0291	140,00X5,00
O-RİNG	60-0000.0294	140,00X7,50
O-RİNG	60-0000.0294	140,00X8,50
O-RİNG	60-0000.0292	142,00X5,34
O-RİNG	60-0000.0773	142,87X3,17
O-RİNG	60-0000.0262	143,00X8,00
O-RİNG	60-0000.0102	145,00X2,50
O-RİNG	60-0000.0197	145,00X3,00
O-RİNG	60-0000.0211	145,00X4,00
O-RİNG	60-0000.0311	145,00X9,00
O-RİNG	60-0000.0356	145,00X14,00
O-RİNG	60-0000.0419	146,00X3,00
O-RİNG	60-0000.0794	146,00X11,00
O-RİNG	60-0000.0005	147,00X2,00
O-RİNG	60-0000.0787	147,50X5,80
O-RİNG	60-0000.0261	148,00X3,00
O-RİNG	60-0000.0522	148,00X5,33
O-RİNG	60-0000.0221	148,00X8,70
O-RİNG	60-0000.0633	149,20X5,33
O-RİNG	60-0000.0201	150,00X3,00
O-RİNG	60-0000.0420	150,00X3,50

O-RİNG İSO		
TİP	REF. NO	ÖLÇÜ
		$\emptyset d_1 \times \emptyset d_2$
O-RİNG	60-0000.0321	150,00X4,00
O-RİNG	60-0000.0016	150,00X5,00
O-RİNG	60-0000.0314	150,00X16,00
O-RİNG	60-0000.0517	151,77X5,33
O-RİNG	60-0000.0088	152,00X4,20
O-RİNG	60-0000.0773	152,40X3,17
O-RİNG	60-0000.0241	155,00X2,62
O-RİNG	60-0000.0198	155,00X4,00
O-RİNG	60-0000.0315	155,00X5,00
O-RİNG	60-0000.0348	155,00X10,00
O-RİNG	60-0000.0622	157,00X2,50
O-RİNG	60-0000.0361	158,00X3,50
O-RİNG	60-0000.0795	158,75X3,17
O-RİNG	60-0000.0055	159,00X10,50
O-RİNG	60-0000.0627	160,00X3,75
O-RİNG	60-0000.0594	160,00X4,00
O-RİNG	60-0000.0188	160,00X6,00
O-RİNG	60-0000.0359	160,00X9,00
O-RİNG	60-0000.0502	160,00X10,00
O-RİNG	60-0000.0089	162,00X7,50
O-RİNG	60-0000.0076	162,00X8,00
O-RİNG	60-0000.0243	163,00X5,50
O-RİNG	60-0000.0074	163,00X10,00
O-RİNG	60-0000.0415	164,50X8,40
O-RİNG	60-0000.0790	165,00X3,00
O-RİNG	60-0000.0388	165,00X4,00
O-RİNG	60-0000.0588	165,00X10,00
O-RİNG	60-0000.0281	168,00X10,00
O-RİNG	60-0000.0650	168,00X11,00
O-RİNG	60-0000.0786	169,30X5,70
O-RİNG	60-0000.0227	170,00X3,00
O-RİNG	60-0000.0264	170,00X3,50
O-RİNG	60-0000.0418	170,00X4,00

O-RİNG İSO		
TİP	REF. NO	ÖLÇÜ
		$\varnothing d_1 \times \varnothing d_2$
O-RİNG	60-0000.0274	170,00X5,34
O-RİNG	60-0000.0010	171,00X8,00
O-RİNG	60-0000.0617	172,00X5,00
O-RİNG	60-0000.0169	173,00X7,00
O-RİNG	60-0000.0349	175,00X4,00
O-RİNG	60-0000.0022	175,00X5,00
O-RİNG	60-0000.0309	176,00X7,00
O-RİNG	60-0000.0515	177,00X3,53
O-RİNG	60-0000.0073	177,00X11,00
O-RİNG	60-0000.0358	177,40X5,33
O-RİNG	60-0000.0548	179,00X2,00
O-RİNG	60-0000.0201	180,00X3,00
O-RİNG	60-0000.0186	180,00X4,00
O-RİNG	60-0000.0019	180,00X5,50
O-RİNG	60-0000.0189	180,00X6,00
O-RİNG	60-0000.0293	182,00X5,00
O-RİNG	60-0000.0017	182,00X8,00
O-RİNG	60-0000.0558	183,00X10,2
O-RİNG	60-0000.0524	183,74X3,53
O-RİNG	60-0000.0768	184,50X8,40
O-RİNG	60-0000.0624	185,00X4,76
O-RİNG	60-0000.0024	185,00X6,00
O-RİNG	60-0000.0263	186,00X5,50
O-RİNG	60-0000.0072	186,30X5,70
O-RİNG	60-0000.0242	186,70X6,00
O-RİNG	60-0000.0034	187,00X12,00
O-RİNG	60-0000.0538	189,00X5,33
O-RİNG	60-0000.0586	190,00X2,50
O-RİNG	60-0000.0213	190,00X3,50
O-RİNG	60-0000.0544	190,00X4,00
O-RİNG	60-0000.0360	190,00X5,00
O-RİNG	60-0000.0051	190,00X7,00
O-RİNG	60-0000.0036	190,00X10,00
O-RİNG	60-0000.0229	190,00X11,00
O-RİNG	60-0000.0347	190,00X12,00
O-RİNG	60-0000.0329	192,00X4,00
O-RİNG	60-0000.0245	195,00X3,00
O-RİNG	60-0000.0219	195,00X4,00
O-RİNG	60-0000.0212	195,00X6,00
O-RİNG	60-0000.0383	196,40X3,50
O-RİNG	60-0000.0012	197,00X8,00
O-RİNG	60-0000.0292	198,00X7,00
O-RİNG	60-0000.0489	198,00X8,50
O-RİNG	60-0000.0582	200,00X1,60

O-RİNG İSO		
TİP	REF. NO	ÖLÇÜ
		$\varnothing d_1 \times \varnothing d_2$
O-RİNG	60-0000.0264	200,00X3,50
O-RİNG	60-0000.0227	200,00X4,00
O-RİNG	60-0000.0100	200,00X5,50
O-RİNG	60-0000.0225	200,00X8,00
O-RİNG	60-0000.0293	205,00X5,00
O-RİNG	60-0000.0024	205,00X6,00
O-RİNG	60-0000.0523	205,00X7,50
O-RİNG	60-0000.0787	205,84X5,33
O-RİNG	60-0000.0234	206,00X3,00
O-RİNG	60-0000.0312	206,00X7,00
O-RİNG	60-0000.0219	208,00X3,00
O-RİNG	60-0000.0245	208,00X4,00
O-RİNG	60-0000.0537	208,00X5,33
O-RİNG	60-0000.0201	208,90X7,00
O-RİNG	60-0000.0538	209,20X5,57
O-RİNG	60-0000.0580	210,00X4,00
O-RİNG	60-0000.0016	210,00X5,00
O-RİNG	60-0000.0212	210,00X8,50
O-RİNG	60-0000.0358	210,00X10,20
O-RİNG	60-0000.0275	212,00X6,50
O-RİNG	60-0000.0010	214,00X8,00
O-RİNG	60-0000.0328	215,00X7,50
O-RİNG	60-0000.0262	215,00X8,00
O-RİNG	60-0000.0795	215,90X3,17
O-RİNG	60-0000.0328	217,00X7,00
O-RİNG	60-0000.0326	217,00X16,00
O-RİNG	60-0000.0019	218,00X6,00
O-RİNG	60-0000.0242	218,00X6,30
O-RİNG	60-0000.0320	219,30X5,70
O-RİNG	60-0000.0284	220,00X2,50
O-RİNG	60-0000.0220	220,00X4,00
O-RİNG	60-0000.0269	220,00X5,00
O-RİNG	60-0000.0321	220,00X6,00
O-RİNG	60-0000.0268	220,00X10,00
O-RİNG	60-0000.0524	220,66X3,53
O-RİNG	60-0000.0388	224,00X3,80
O-RİNG	60-0000.0283	225,00X6,50
O-RİNG	60-0000.0414	225,00X7,00
O-RİNG	60-0000.0037	225,00X14,50
O-RİNG	60-0000.0320	229,30X5,70
O-RİNG	60-0000.0349	230,00X4,00
O-RİNG	60-0000.0321	230,00X6,00
O-RİNG	60-0000.0561	230,00X7,00
O-RİNG	60-0000.0036	230,00X8,00

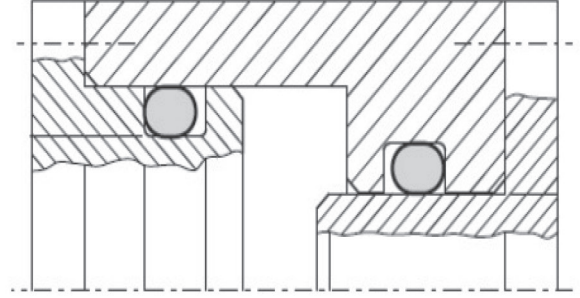
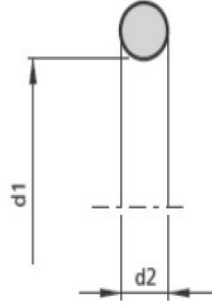

O-RİNG İSO		
TİP	REF. NO	ÖLÇÜ
		$\emptyset d_1 \times \emptyset d_2$
O-RİNG	60-0000.0245	233,00X3,00
O-RİNG	60-0000.0771	234,00X7,00
O-RİNG	60-0000.0785	234,00X13,00
O-RİNG	60-0000.0270	235,00X5,00
O-RİNG	60-0000.0013	237,00X6,00
O-RİNG	60-0000.0327	237,00X7,00
O-RİNG	60-0000.0632	240,00X7,00
O-RİNG	60-0000.0638	240,00X5,70
O-RİNG	60-0000.0558	240,00X10,2
O-RİNG	60-0000.0489	242,00X8,50
O-RİNG	60-0000.0355	245,00X10,2
O-RİNG	60-0000.0581	246,00X8,00
O-RİNG	60-0000.0234	248,00X3,00
O-RİNG	60-0000.0220	250,00X4,00
O-RİNG	60-0000.0319	250,00X5,00
O-RİNG	60-0000.0011	250,00X6,00
O-RİNG	60-0000.0014	250,00X8,00
O-RİNG	60-0000.0383	253,60X3,50
O-RİNG	60-0000.0245	254,00X3,00
O-RİNG	60-0000.0768	254,80X8,40
O-RİNG	60-0000.0269	255,00X5,00
O-RİNG	60-0000.0284	255,00X5,50
O-RİNG	60-0000.0052	255,00X10,00
O-RİNG	60-0000.0108	255,00X14,50
O-RİNG	60-0000.0609	260,00X5,00
O-RİNG	60-0000.0072	260,00X6,35
O-RİNG	60-0000.0629	260,00X7,00
O-RİNG	60-0000.0353	260,00X8,00
O-RİNG	60-0000.0585	265,00X5,75
O-RİNG	60-0000.0221	265,00X6,20
O-RİNG	60-0000.0519	265,00X10,00
O-RİNG	60-0000.0417	270,00X3,00
O-RİNG	60-0000.0013	270,00X5,00

O-RİNG İSO		
TİP	REF. NO	ÖLÇÜ
		$\emptyset d_1 \times \emptyset d_2$
O-RİNG	60-0000.0384	270,00X7,00
O-RİNG	60-0000.0631	275,00X3,00
O-RİNG	60-0000.0204	280,00X3,00
O-RİNG	60-0000.0226	280,00X6,00
O-RİNG	60-0000.0641	284,00X3,50
O-RİNG	60-0000.0392	284,00X4,00
O-RİNG	60-0000.0200	285,00X3,00
O-RİNG	60-0000.0184	285,00X5,00
O-RİNG	60-0000.0518	285,00X10,00
O-RİNG	60-0000.0325	285,75X7,94
O-RİNG	60-0000.0186	287,50X7,00
O-RİNG	60-0000.0630	290,00X4,00
O-RİNG	60-0000.0281	290,00X7,50
O-RİNG	60-0000.0640	294,00X3,50
O-RİNG	60-0000.0416	300,00X3,00
O-RİNG	60-0000.0413	300,00X4,00
O-RİNG	60-0000.0184	300,00X5,00
O-RİNG	60-0000.0222	300,00X10,00
O-RİNG	60-0000.0202	303,50X4,00
O-RİNG	60-0000.0539	304,17X5,33
O-RİNG	60-0000.0540	305,00X10,00
O-RİNG	60-0000.0282	310,00X5,34
O-RİNG	60-0000.0412	310,00X6,00
O-RİNG	60-0000.0380	310,00X10,00
O-RİNG	60-0000.0392	314,00X4,00
O-RİNG	60-0000.0769	315,00X10,00
O-RİNG	60-0000.0354	317,00X6,35
O-RİNG	60-0000.0244	319,30X5,70
O-RİNG	60-0000.0224	320,00X4,00
O-RİNG	60-0000.0651	320,00X12,00
O-RİNG	60-0000.0222	325,00X4,00
O-RİNG	60-0000.0200	330,00X3,00
O-RİNG	60-0000.0560	330,00X10,70

O-RİNG İSO		
TİP	REF. NO	ÖLÇÜ
		$\varnothing d_1 \times \varnothing d_2$
O-RİNG	60-0000.0621	334,00X8,00
O-RİNG	60-0000.0222	336,00X6,00
O-RİNG	60-0000.0244	339,30X5,70
O-RİNG	60-0000.0353	343,00X7,00
O-RİNG	60-0000.0316	345,00X6,00
O-RİNG	60-0000.0343	345,00X8,00
O-RİNG	60-0000.0350	350,00X6,00
O-RİNG	60-0000.0380	350,00X8,00
O-RİNG	60-0000.0615	350,50X3,53
O-RİNG	60-0000.0600	356,00X5,33
O-RİNG	60-0000.0379	358,00X8,60
O-RİNG	60-0000.0223	365,00X6,00
O-RİNG	60-0000.0295	370,00X4,00
O-RİNG	60-0000.0542	370,00X10,00
O-RİNG	60-0000.0202	375,00X3,50
O-RİNG	60-0000.0350	375,00X6,00
O-RİNG	60-0000.0343	379,00X5,70
O-RİNG	60-0000.0623	380,00X10,00
O-RİNG	60-0000.0520	386,00X6,00
O-RİNG	60-0000.0203	400,00X6,00
O-RİNG	60-0000.0301	400,00X7,00
O-RİNG	60-0000.0341	400,00X10,00
O-RİNG	60-0000.0578	405,26X5,33
O-RİNG	60-0000.0652	405,00X7,00
O-RİNG	60-0000.0380	420,00X8,30
O-RİNG	60-0000.0191	425,00X7,00
O-RİNG	60-0000.0651	430,00X4,00
O-RİNG	60-0000.0343	440,00X10,00
O-RİNG	60-0000.0583	441,00X5,00
O-RİNG	60-0000.0341	450,00X5,70
O-RİNG	60-0000.0652	460,00X5,00
O-RİNG	60-0000.0203	465,00X6,00
O-RİNG	60-0000.0578	500,00X7,00
O-RİNG	60-0000.0203	505,00X6,00
O-RİNG	60-0000.0625	510,00X5,00
O-RİNG	60-0000.0799	520,00X7,00
O-RİNG	60-0000.0584	540,00X5,00
O-RİNG	60-0000.0579	560,00X5,00

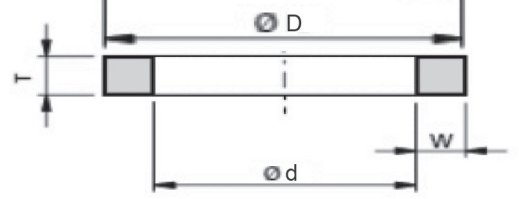
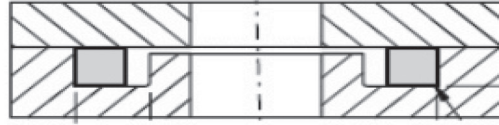

KARE RİNG İS115		
TİP	REF. NO	ÖLÇÜ $\text{ød} \times \text{øD} \times T$
İS115	61-079.0000	1,5X7X5
İS115	61-044.0000	2,4X6,5X2,5
İS115	61-257.0000	2,5X5,8X2
İS115	61-063.0000	2,5X22,5X2,5
İS115	61-243.0000	3X16X7
İS115	61-195.0000	3X90X5
İS115	61-072.0000	3,5X9X4
İS115	61-072.0000	3,5X14X3
İS115	61-091.0000	4X8,7X4
İS115	61-296.0000	4X30X2
İS115	61-036.0000	4,9X15X1,5
İS115	61-309.0000	5X8X3
İS115	61-148.0000	5X8X3,5
İS115	61-281.0000	5X9X2
İS115	61-004.0000	5X9,7X7,2
İS115	61-004.0000	5X10X12,2
İS115	61-183.0000	5X11X2,2
İS115	61-137.0000	5X14X2,2
İS115	61-203.0000	5X16X4
İS115	61-298.0000	5X16X6
İS115	61-181.0000	5,5X10,7X4
İS115	61-117.0000	5,5X12X3,2
İS115	61-118.0000	5,5X17X3
İS115	61-309.0000	5,5X20X1
İS115	61-353.0000	5,5X25X4
İS115	61-111.0000	5,5X25,5X4,5
İS115	61-247.0000	6X10X4,7
İS115	61-171.0000	6X12X1,5
İS115	61-259.0000	6X12X3
İS115	61-302.0000	6X12,5X8
İS115	61-041.0000	6X15X4,1
İS115	61-109.0000	6X16X3
İS115	61-101.0000	6X18X3

KARE RİNG İS115		
TİP	REF. NO	ÖLÇÜ $\text{ød} \times \text{øD} \times T$
İS115	61-048.0000	6X22X5
İS115	61-338.0000	6X26X4,5
İS115	61-112.0000	6X27X3,5
İS115	61-206.0000	6X30X18
İS115	61-048.0000	6X33X5
İS115	61-160.0000	6X40X3,5
İS115	61-187.0000	6X43X5
İS115	61-312.0000	6X45X8
İS115	61-112.0000	6X55X4,5
İS115	61-015.0000	6,3X14,3X2,2
İS115	61-208.0000	6,3X16,3X3
İS115	61-024.0000	6,35X20X5
İS115	61-166.0000	6,4X13X2,5
İS115	61-166.0000	6,5X11X2,5
İS115	61-167.0000	6,5X12,5X3
İS115	61-062.0000	6,5X14,5X2,1
İS115	61-315.0000	6,5X20X5
İS115	61-315.0000	6,5X20X5
İS115	61-315.0000	6,5X20X5
İS115	61-306.0000	6,5X26X1
İS115	61-302.0000	6,8X18,4X6
İS115	61-165.0000	7X2,5
İS115	61-295.0000	7X3
İS115	61-128.0000	7X10X4,8
İS115	61-250.0000	7X11,5X3,3
İS115	61-277.0000	7X11,5X3,5
İS115	61-130.0000	7X13X3
İS115	61-349.0000	7X13,5X6,5
İS115	61-148.0000	7X14X4,5
İS115	61-354.0000	7X21X3
İS115	61-016.0000	7X24X2
İS115	61-336.0000	7X25X1
İS115	61-240.0000	7,2X12,2X12,5

KARE RİNG İS115		
TİP	REF. NO	ÖLÇÜ
		ød x øD x T
İS115	61-209.0000	7,2X16,2X2,5
İS115	61-050.0000	7,2X20X2
İS115	61-256.0000	7,5X14,3X2,8
İS115	61-205.0000	7,55X16X3,3
İS115	61-156.0000	7,7X40,5X2,6
İS115	61-321.0000	7,7X4,5X3
İS115	61-339.0000	7,8X19,2X4,5
İS115	61-114.0000	7,8X44,8X3
İS115	61-204.0000	8X13,5X3
İS115	61-343.0000	8X14X9
İS115	61-231.0000	8X15X4,5
İS115	61-075.0000	8X16X3,5
İS115	61-130.0000	8X16,2X7
İS115	61-341.0000	8X16,5X4
İS115	61-219.0000	8X17X3
İS115	61-108.0000	8X18,5X3
İS115	61-314.0000	8X20X5
İS115	61-009.0000	8X22X4,2
İS115	61-080.0000	8X24X4,5
İS115	61-067.0000	8,2X16X21,8
İS115	61-210.0000	8,2X45X5
İS115	61-317.0000	8,5X12,5X2
İS115	61-068.0000	8,5X15,5X22
İS115	61-131.0000	8,5X18X4,8
İS115	61-339.0000	8,5X21,8X8
İS115	61-334.0000	9X13X12
İS115	61-066.0000	9X13,2X12
İS115	61-165.0000	9X16X3,3
İS115	61-373.0000	9X22X8
İS115	61-081.0000	9X35X4,2
İS115	61-337.0000	9X51X4
İS115	61-249.0000	9,5X13,5X1,9
İS115	61-163.0000	9,5X15,5X3,3
İS115	61-194.0000	9,5X16X1,60
İS115	61-341.0000	9,5X26X3,7
İS115	61-139.0000	9,5X27X4
İS115	61-140.0000	9,8X14,2X3,8
İS115	61-085.0000	10X12,5X1,8
İS115	61-329.0000	10X12,6X1,1
İS115	61-083.0000	10X13X1,9
İS115	61-307.0000	10X14X3,5
İS115	61-242.0000	10X14,2X12
İS115	61-128.0000	10X15X4,8
İS115	61-003.0000	10X15X5,5

KARE RİNG İS115		
TİP	REF. NO	ÖLÇÜ
		ød x øD x T
İS115	61-303.0000	10X16X3
İS115	61-308.0000	10X18X3
İS115	61-261.0000	10X19X1,8
İS115	61-129.0000	10X19X2
İS115	61-314.0000	10X22X8
İS115	61-301.0000	10X24X1,1
İS115	61-305.0000	10X24X4
İS115	61-282.0000	10X28X10
İS115	61-089.0000	10X35X5
İS115	61-269.0000	10X37X3
İS115	61-089.0000	10X40X5
İS115	61-089.0000	10X50X5
İS115	61-090.0000	10X60X5
İS115	61-090.0000	10X70X5
İS115	61-172.0000	10X26X4,5
İS115	61-249.0000	10,2X12,5X1,6
İS115	61-076.0000	10,5X30X20,5
İS115	61-252.0000	10,8X15,2X1,5
İS115	61-345.0000	11X16X1,5
İS115	61-318.0000	11X25X1,5
İS115	61-192.0000	11X27,5X3,2
İS115	61-031.0000	11,2X15,6X1,5
İS115	61-116.0000	11,3X24,8X8
İS115	61-245.0000	11,5X226X11,5
İS115	61-255.0000	11,7X3
İS115	61-081.0000	11,7X47X5
İS115	61-066.0000	11,8X16,2X12
İS115	61-254.0000	12X3,2
İS115	61-211.0000	12X18X3,3
İS115	61-178.0000	12X18,5X3,7
İS115	61-323.0000	12X21X2,2
İS115	61-123.0000	12X21X6,5
İS115	61-273.0000	12X21,4X4,75
İS115	61-246.0000	12X22X6
İS115	61-104.0000	12X22,5X5
İS115	61-125.0000	12X23X3
İS115	61-221.0000	12X25
İS115	61-124.0000	12X27X5,5
İS115	61-230.0000	12X29,5X3
İS115	61-081.0000	12X59X6
İS115	61-095.0000	12,3X3,5
İS115	61-066.0000	12,5X16,4X15
İS115	61-111.0000	12,5X26,5X5
İS115	61-176.0000	12,5X27X5,8

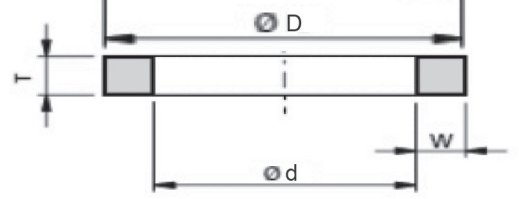
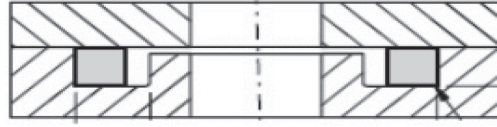

KARE RİNG İS115		
TİP	REF. NO	ÖLÇÜ
		$\text{ød} \times \text{øD} \times T$
İS115	61-100.0000	12,5X28,5X4
İS115	61-145.0000	12,5X40X1,7
İS115	61-263.0000	13X16X2
İS115	61-120.0000	13X18X45
İS115	61-029.0000	13X24X12
İS115	61-223.0000	13,2X20,75X27
İS115	61-158.0000	13,4X20,2X1,7
İS115	61-030.0000	13,5X20X12
İS115	61-175.0000	13,5X24X3,5
İS115	61-279.0000	14X4
İS115	61-236.0000	14X22X5
İS115	61-017.0000	14X23X3
İS115	61-251.0000	14X28,5X3
İS115	61-338.0000	14X40,5X3
İS115	61-233.0000	14X75X8
İS115	61-153.0000	14,5X28X3,5
İS115	61-270.0000	15X2
İS115	61-270.0000	15X2,2
İS115	61-126.0000	15X20,5X2
İS115	61-193.0000	15X21X1
İS115	61-190.0000	15X28X32
İS115	61-009.0000	15X32,7X4
İS115	61-241.0000	15X34X14
İS115	61-324.0000	16X2
İS115	61-066.0000	16X20X15
İS115	61-068.0000	16X21,8
İS115	61-049.0000	16X42X7
İS115	61-049.0000	16X51X7
İS115	61-042.0000	16X62X8
İS115	61-012.0000	17X23X2
İS115	61-222.0000	17,3X30,25
İS115	61-200.0000	18X28X6,5
İS115	61-202.0000	18X30X10,4

KARE RİNG İS115		
TİP	REF. NO	ÖLÇÜ
		$\text{ød} \times \text{øD} \times T$
İS115	61-139.0000	18X54X3,5
İS115	61-052.0000	18,5X25X2,8
İS115	61-055.0000	18,5X25X2,8
İS115	61-220.0000	19X25
İS115	61-014.0000	19X25X3,5
İS115	61-275.0000	19X55X4,5
İS115	61-344.0000	19X60X5
İS115	61-077.0000	19X76X2
İS115	61-014.0000	19X25X3,5
İS115	61-275.0000	19X55X4,5
İS115	61-344.0000	19X60X5
İS115	61-077.0000	19X76X2
İS115	61-039.0000	19,4X38X30
İS115	61-248.0000	19,5X25,5X3,17
İS115	61-253.0000	19,8X25,5X3,3
İS115	61-272.0000	20X2,5
İS115	61-285.0000	20X24X2
İS115	61-287.0000	20X25X2,5
İS115	61-157.0000	20X25X4
İS115	61-288.0000	20X28X4
İS115	61-286.0000	20X30X3
İS115	61-289.0000	20X30X5
İS115	61-047.0000	20X45X5
İS115	61-189.0000	20X42,5X3
İS115	61-342.0000	20X60X20
İS115	61-294.0000	20X520X10
İS115	61-309.0000	20,5X1
İS115	61-182.0000	20,5X24,5X1,65
İS115	61-260.0000	21X25X2
İS115	61-162.0000	21X30X2,2
İS115	61-224.0000	21,4X39,15X2,8
İS115	61-227.0000	21,4X61X19,4
İS115	61-249.0000	22X26,5X2,4

KARE RİNG İS115		
TİP	REF. NO	ÖLÇÜ
		ød x øD x T
İS115	61-135.0000	22X27X2,5
İS115	61-051.0000	22X36X7
İS115	61-121.0000	22X36,5X10,3
İS115	61-249.0000	22X38X5
İS115	61-097.0000	22,5X33,5X2,5
İS115	61-149.0000	23X33X2
İS115	61-057.0000	23X33,6X3,5
İS115	61-110.0000	24X44,5X2
İS115	61-177.0000	24X56X6,8
İS115	61-217.0000	24,5X111,5X5,8
İS115	61-246.0000	24,5X111,5X5,8
İS115	61-268.0000	25X31X3,2
İS115	61-087.0000	25X32X5,5
İS115	61-027.0000	25X39X7
İS115	61-127.0000	25X40X2
İS115	61-046.0000	25X50X8
İS115	61-234.0000	25X79,5X7,7
İS115	61-152.0000	26X28,5X1,5
İS115	61-212.0000	26X39,5X5,8
İS115	61-053.0000	26,5X32,5X2,8
İS115	61-056.0000	26,5X32,5X2,8
İS115	61-206.0000	27X33X3,5
İS115	61-022.0000	27X36X5,5
İS115	61-169.0000	28X40X5
İS115	61-225.0000	28,15X45X3
İS115	61-333.0000	28,50X48,5X6
İS115	61-191.0000	29,5X43,5X3,85
İS115	61-285.0000	30X34X2
İS115	61-028.0000	30X35X2,5
İS115	61-286.0000	30X36X3
İS115	61-288.0000	30X38X4
İS115	61-105.0000	30X40X3
İS115	61-164.0000	30X40X3,5
İS115	61-289.0000	30X40X5
İS115	61-092.0000	30X42,2X2,3
İS115	61-185.0000	30X55X3
İS115	61-032.0000	30X60X2
İS115	61-198.0000	30X73X3
İS115	61-040.0000	30,2X57,5X40
İS115	61-278.0000	30,5X34,2X3
İS115	61-199.0000	30,5X40,5X3,5
İS115	61-238.0000	30,5X40,5X40
İS115	61-045.0000	30,7X83X2
İS115	61-335.0000	31,5X37X3,5

KARE RİNG İS115		
TİP	REF. NO	ÖLÇÜ
		ød x øD x T
İS115	61-162.0000	31,5X39X2,2
İS115	61-280.0000	32X46X3,5
İS115	61-154.0000	32X49X2,5
İS115	61-103.0000	32X49X9
İS115	61-098.0000	33X40X3,5
İS115	61-162.0000	33X45X2,5
İS115	61-262.0000	34,5X39X2
İS115	61-243.0000	33,8X63,5X14,5
İS115	61-274.0000	35X3,5
İS115	61-141.0000	35X40,5X4
İS115	61-300.0000	35X42X13
İS115	61-054.0000	35X46,5X2
İS115	61-316.0000	36X0,5
İS115	61-021.0000	36X46X4
İS115	61-170.0000	36X48X5
İS115	61-218.0000	36X50X2,7
İS115	61-238.0000	36X104X25
İS115	61-276.0000	36,2X50X3
İS115	61-061.0000	37X45X5,2
İS115	61-264.0000	37,5X43,5X5
İS115	61-297.0000	38X44X5
İS115	61-084.0000	38X45X3,4
İS115	61-350.0000	38X48X3
İS115	61-087.0000	38X48X5,5
İS115	61-070.0000	38X63,5X13
İS115	61-119.0000	39,5X47,5X3
İS115	61-078.0000	39,5X106X6,5
İS115	61-144.0000	40X0,2
İS115	61-144.0000	40X0,3
İS115	61-144.0000	40X0,4
İS115	61-262.0000	40X43X1,2
İS115	61-285.0000	40X44X2
İS115	61-287.0000	40X45X2,5
İS115	61-286.0000	40X46X3
İS115	61-288.0000	40X48X4
İS115	61-289.0000	40X50X5
İS115	61-023.0000	40X57X2
İS115	61-042.0000	40X86X10
İS115	61-207.0000	40,5X44X3
İS115	61-018.0000	40,5X65X2,7
İS115	61-313.0000	40,5X66X4
İS115	61-226.0000	40,85X60,75
İS115	61-019.0000	43X48X10
İS115	61-267.0000	43X51X2,6

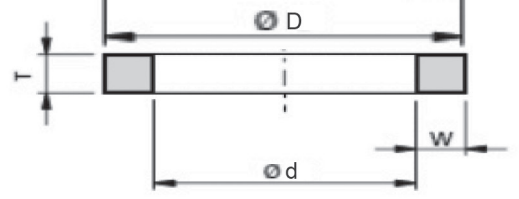
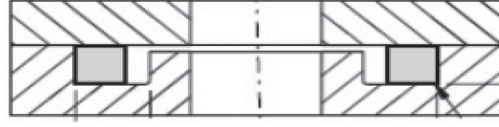

KARE RİNG İS115		
TİP	REF. NO	ÖLÇÜ
		$\text{ød} \times \text{øD} \times T$
İS115	61-001.0000	44X54X0,5
İS115	61-133.0000	45X55X20
İS115	61-142.0000	45X58X6,5
İS115	61-159.0000	45X59X2,5
İS115	61-093.0000	45X60X2,3
İS115	61-232.0000	45X60X2,5
İS115	61-271.0000	45X84X8
İS115	61-094.0000	45,2X60,3X2,4
İS115	61-106.0000	46X52X3
İS115	61-136.0000	46X54X2,5
İS115	61-174.0000	46X75X5,5
İS115	61-060.0000	47X55X7
İS115	61-027.0000	47X66X6
İS115	61-102.0000	47X69X9
İS115	61-014.0000	47,5X56X7
İS115	61-319.0000	48X59X5
İS115	61-002.0000	48X73X5
İS115	61-348.0000	49X7
İS115	61-168.0000	49X58X5,5
İS115	61-155.0000	49X60,5X6
İS115	61-185.0000	50X54X2
İS115	61-287.0000	50X55X2,5
İS115	61-286.0000	50X56X3
İS115	61-288.0000	50X58X4
İS115	61-289.0000	50X60X5
İS115	61-320.0000	50X65X5
İS115	61-010.0000	50X67X5,4
İS115	61-107.0000	50,5X61X4
İS115	61-043.0000	50X95X10
İS115	61-047.0000	50X104X5
İS115	61-047.0000	50X140X5
İS115	61-008.0000	51X58X3,5
İS115	61-340.0000	52X69X7

KARE RİNG İS115		
TİP	REF. NO	ÖLÇÜ
		$\text{ød} \times \text{øD} \times T$
İS115	61-323.0000	53X89X5
İS115	61-005.0000	55X61X11
İS115	61-179.0000	55X72X3,5
İS115	61-038.0000	56X66X1,5
İS115	61-319.0000	56X67X5
İS115	61-069.0000	56X74,5X9,5
İS115	61-284.0000	56,5X66,5X5
İS115	61-082.0000	58X3
İS115	61-037.0000	58X66X4
İS115	61-086.0000	59X103X5
İS115	61-150.0000	60X4
İS115	61-064.0000	60X9
İS115	61-285.0000	60X64X2
İS115	61-287.0000	60X65X2,5
İS115	61-286.0000	60X66X3
İS115	61-288.0000	60X68X4
İS115	61-138.0000	60X70X5
İS115	61-214.0000	60X70X7,5
İS115	61-184.0000	60X78,5X3,5
İS115	61-007.0000	61X68X40
İS115	61-215.0000	61X67X5,5
İS115	61-151.0000	61X71,5X3,5
İS115	61-196.0000	61,5X68,5X3,5
İS115	61-161.0000	62X74X8
İS115	61-283.0000	62X99X20
İS115	61-026.0000	63,2X68,4X1,8
İS115	61-351.0000	64,3X87X3
İS115	61-331.0000	65X70X3,5
İS115	61-086.0000	66X73X3,8
İS115	61-322.0000	66X76X3
İS115	61-304.0000	68X100X13
İS115	61-347.0000	68,5X75X1,5
İS115	61-071.0000	69X89X3

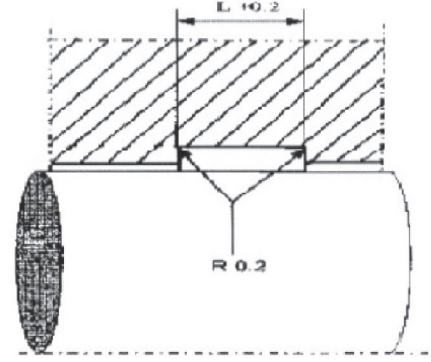
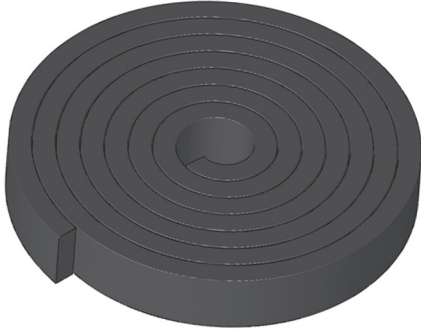

BRONZLU PTFE YATAKLAMA İS80				
KODU	REF.NO		H	S
İS80	43-5001.0001	BRONZLU YATAKLAMA	5,00	1,00
İS80	43-4015.0002	BRONZLU YATAKLAMA	4,00	1,50
İS80	43-5515.0003	BRONZLU YATAKLAMA	5,50	1,50
İS80	43-8015.0004	BRONZLU YATAKLAMA	8,00	1,50
İS80	43-9515.0005	BRONZLU YATAKLAMA	9,50	1,50
İS80	43-8002.0006	BRONZLU YATAKLAMA	8,00	2,00
İS80	43-9502.0007	BRONZLU YATAKLAMA	9,50	2,00
İS80	43-1002.0008	BRONZLU YATAKLAMA	10,00	2,00
İS80	43-1202.0009	BRONZLU YATAKLAMA	12,00	2,00
İS80	43-1502.0010	BRONZLU YATAKLAMA	15,00	2,00
İS80	43-2002.0011	BRONZLU YATAKLAMA	20,00	2,00
İS80	43-2502.0012	BRONZLU YATAKLAMA	25,00	2,00
İS80	43-3002.0013	BRONZLU YATAKLAMA	30,00	2,00
İS80	43-5525.0014	BRONZLU YATAKLAMA	5,50	2,50
İS80	43-8025.0015	BRONZLU YATAKLAMA	8,00	2,50
İS80	43-9525.0016	BRONZLU YATAKLAMA	9,50	2,50
İS80	43-1025.0017	BRONZLU YATAKLAMA	10,00	2,50
İS80	43-1225.0018	BRONZLU YATAKLAMA	12,00	2,50
İS80	43-1525.0019	BRONZLU YATAKLAMA	15,00	2,50
İS80	43-2025.0020	BRONZLU YATAKLAMA	20,00	2,50
İS80	43-2525.0021	BRONZLU YATAKLAMA	25,00	2,50

BRONZLU PTFE YATAKLAMA İS80				
KODU	REF.NO		H	S
İS80	43-3025.0022	BRONZLU YATAKLAMA	30,00	2,50
İS80	43-8003.0023	BRONZLU YATAKLAMA	8,00	3,00
İS80	43-9503.0024	BRONZLU YATAKLAMA	9,50	3,00
İS80	43-1203.0025	BRONZLU YATAKLAMA	12,00	3,00
İS80	43-1503.0026	BRONZLU YATAKLAMA	15,00	3,00
İS80	43-2003.0027	BRONZLU YATAKLAMA	20,00	3,00
İS80	43-2503.0028	BRONZLU YATAKLAMA	25,00	3,00
İS80	43-3003.0029	BRONZLU YATAKLAMA	30,00	3,00
İS80	43-3503.0030	BRONZLU YATAKLAMA	35,00	3,00
İS80	43-4003.0031	BRONZLU YATAKLAMA	40,00	3,00
İS80	43-4006.0032	BRONZLU YATAKLAMA	6,00	4,00
İS80	43-4008.0033	BRONZLU YATAKLAMA	8,00	4,00
İS80	43-4095.0034	BRONZLU YATAKLAMA	9,50	4,00
İS80	43-4015.0035	BRONZLU YATAKLAMA	15,00	4,00
İS80	43-4020.0036	BRONZLU YATAKLAMA	20,00	4,00
İS80	43-4025.0037	BRONZLU YATAKLAMA	25,00	4,00
İS80	43-5025.0038	BRONZLU YATAKLAMA	25,00	5,00

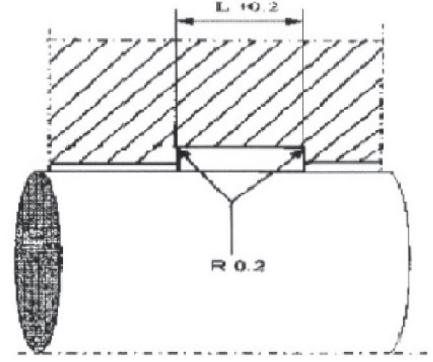
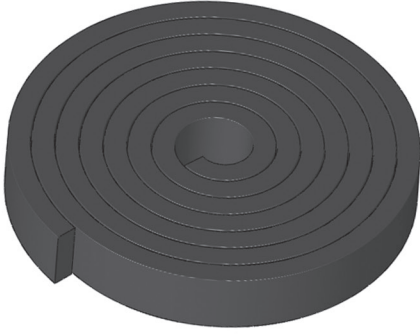

**KARBONLU PTFE YATAKLAMA
İS81**

KODU	REF.NO		H	S
İS81	44-8002.0001	KARBONLU YATAKLAMA	8,00	2,00
İS81	44-9502.0002	KARBONLU YATAKLAMA	9,50	2,00
İS81	44-9525.0003	KARBONLU YATAKLAMA	9,50	2,50
İS81	44-1525.0004	KARBONLU YATAKLAMA	15,00	2,50
İS81	44-9504.0005	KARBONLU YATAKLAMA	9,50	4,00
İS81	44-1504.0006	KARBONLU YATAKLAMA	15,00	4,00

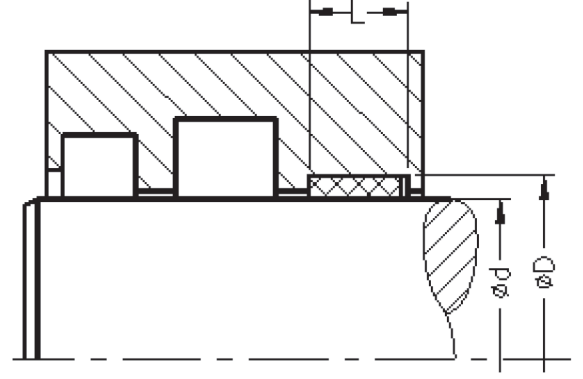

POLYESTER RESİN YATAKLAMA (İTHAL)
İS82

KODU	REF.NO	H	S
İS82	45-1002.0001	10,00	2,00
İS82	45-1502.0002	15,00	2,00
İS82	45-2002.0003	20,00	2,00
İS82	45-2502.0004	25,00	2,00
İS82	45-5625.0005	2,60	2,50
İS82	45-9725.0006	9,70	2,50
İS82	45-1525.0007	15,00	2,50
İS82	45-2025.0008	20,00	2,50
İS82	45-2525.0009	25,00	2,50
İS82	45-3025-0010	30,00	2,50
İS82	45-1003.0011	10,00	3,00
İS82	45-1503.0012	15,00	3,00
İS82	45-2003.0013	20,00	3,00
İS82	45-2503.0014	25,00	3,00
İS82	45-3003.0015	30,00	3,00
İS82	45-1504.0016	15,00	4,00
İS82	45-2004.0017	20,00	4,00
İS82	45-2504.0018	25,00	4,00

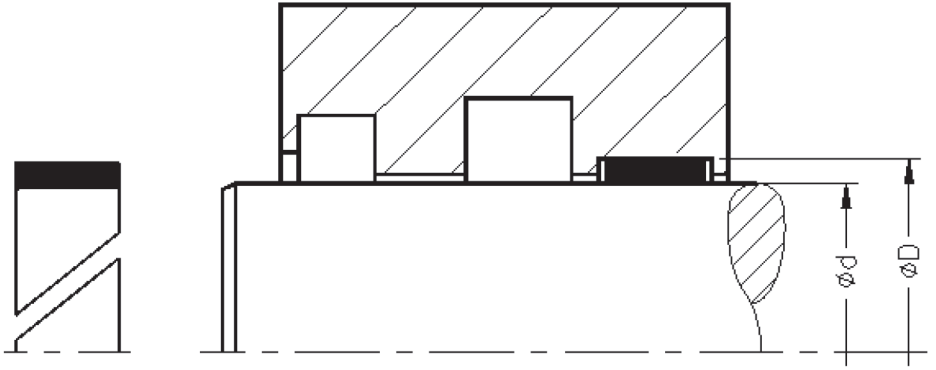

POM RİNG BOĞAZ YATAKLAMA İS83				
TİP	REF. NO	$\varnothing d$	$\varnothing D$	B
İS83	68-4001.0001	40	45	9,7
İS83	68-4005.0002	40	45	15
İS83	68-4507.0003	45	50	9,7
İS83	68-4505.0004	45	50	15
İS83	68-5007.0005	50	55	9,7
İS83	68-5005.0006	50	55	15
İS83	68-5507.0007	55	60	9,7
İS83	68-5505.0008	55	60	15
İS83	68-6007.0009	60	65	9,7
İS83	68-6005.0010	60	65	15
İS83	68-6507.0011	65	70	9,7
İS83	68-6505.0012	65	70	15
İS83	68-7007.0013	70	75	9,7
İS83	68-7005.0014	70	75	15
İS83	68-7507.0015	75	80	9,7
İS83	68-7505.0016	75	80	15
İS83	68-8007.0017	80	85	9,7
İS83	68-8005.0018	80	85	15
İS83	68-8507.0019	85	90	9,7
İS83	68-8505.0020	85	90	15
İS83	68-9007.0021	90	95	9,7
İS83	68-9005.0022	90	95	15
İS83	68-9507.0023	95	100	9,7
İS83	68-9505.0024	95	100	15
İS83	68-1007.0025	100	105	9,7
İS83	68-1005.0026	100	105	15
İS83	68-1000.0027	100	105	20
İS83	68-1007.0028	105	110	9,7
İS83	68-1005.0029	105	110	15
İS83	68-1107.0030	110	115	9,7
İS83	68-1105.0031	110	115	15
İS83	68-1100.0032	110	115	20
İS83	68-1107.0033	115	120	9,7

POM RİNG BOĞAZ YATAKLAMA İS83				
TİP	REF. NO	$\varnothing d$	$\varnothing D$	B
İS83	68-1105.0034	115	120	15
İS83	68-1100.0035	115	120	20
İS83	68-1207.0036	120	125	9,7
İS83	68-1205.0037	120	125	15
İS83	68-1205.0038	120	125	25
İS83	68-1257.0039	125	130	9,7
İS83	68-1255.0040	125	130	15
İS83	68-1307.0041	130	135	9,7
İS83	68-1305.0042	130	135	15
İS83	68-1357.0043	135	140	9,7
İS83	68-1355.0044	135	140	15
İS83	68-1407.0045	140	145	9,7
İS83	68-1405.0046	140	145	15
İS83	68-1457.0047	145	150	9,7
İS83	68-1455.0048	145	150	15
İS83	68-1507.0049	150	155	9,7
İS83	68-1505.0050	150	155	15
İS83	68-1557.0051	155	160	9,7
İS83	68-1555.0052	155	160	15
İS83	68-1607.0053	160	165	9,7
İS83	68-1605.0054	160	165	15
İS83	68-1657.0055	165	170	9,7
İS83	68-1655.0056	165	170	15
İS83	68-1757.0057	175	180	9,7
İS83	68-1755.0058	175	180	15
İS83	68-1807.0059	180	185	9,7
İS83	68-1805.0060	180	185	15
İS83	68-1857.0061	185	190	9,7
İS83	68-1855.0062	185	190	15
İS83	68-1957.0063	195	200	9,7
İS83	68-1855.0064	195	200	15

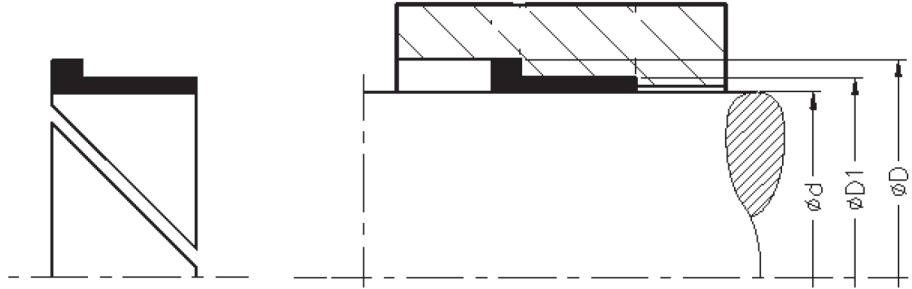

TELESKOPIK YATAKLAMA
İS87

TİP	REF. NO	$\varnothing d / \varnothing D_1$	$\varnothing D$	B
İS87	42-7535.0001	75/80	85	30/5
İS87	42-9535.0002	95/100	105	30/5
İS87	42-1135.0003	115/120	125	30/5
İS87	42-1335.0004	135/140	145	30/5
İS87	42-1635.0005	160/165	170	30/5
İS87	42-1835.0006	185/191	195	30/5
İS87	42-2135.0007	215/221	225	30/5



İŞLER KAUÇUK
Sızdırmazlık Teknolojileri

Fabrika

Abdi İpekçi Caddesi 1. Emintaş San. Sit.
No: 158/53 Bayrampaşa / İstanbul
Tel : (0212) 674 69 21 pbx
Faks : (0212) 674 69 25

Şube

H/S GROUP EOOD
S. Tazha; obsh. Pavel banya; ul. "Partizanska" 20
Obl. Stara Zagora / BULGARIA
Tel.: +35 988 658 08 42
+35 989 344 50 56

Şube

SUSZI INDUSTRIAL
2M Constantei Road, Cumpana
Constanta / Romania
Tel : +40 241 61 93 93
Faks : +40 241 61 93 83

www.islerkaucuk.com
isler@islerltd.com